

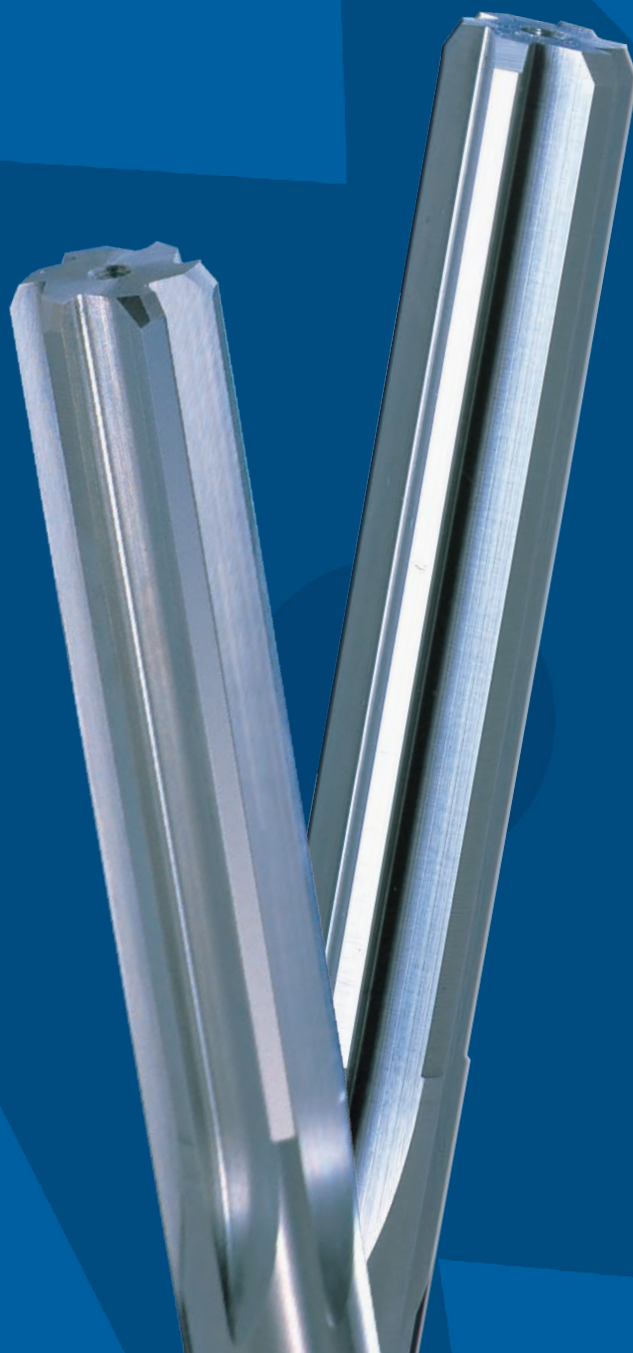

Carbide straight reamer

CRM

Volume 2

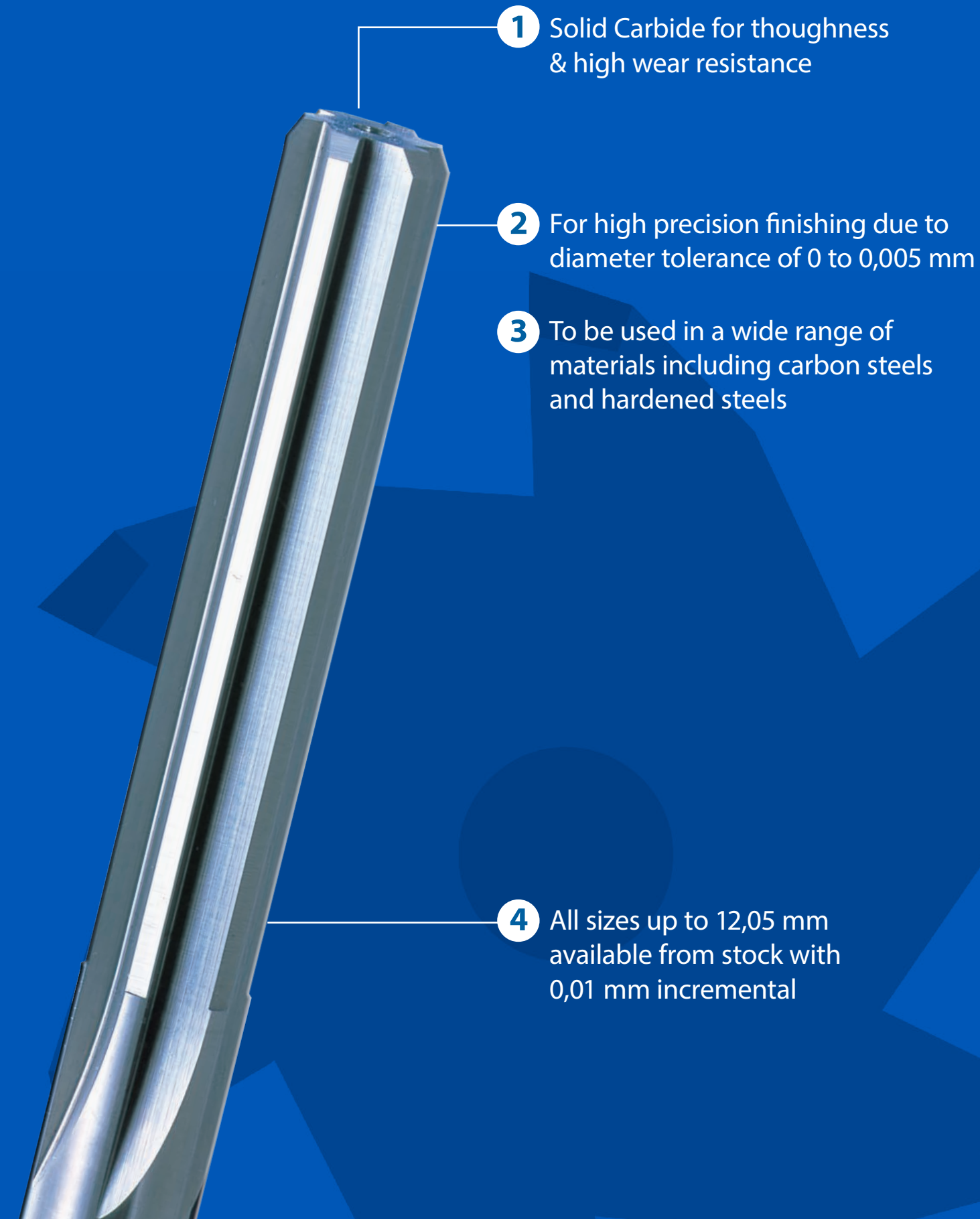

FEATURES: REAMER CRM

- 
- 1** Solid Carbide for toughness & high wear resistance
 - 2** For high precision finishing due to diameter tolerance of 0 to 0,005 mm
 - 3** To be used in a wide range of materials including carbon steels and hardened steels
 - 4** All sizes up to 12,05 mm available from stock with 0,01 mm incremental

CUTTING DATA

The surface roughness and amount of oversize at different cutting speeds

Cutting Conditions

Work Material	S50C (JIS S50C,AISI 1050)
Reamer Size	10 mm
Feed	0,2 mm/rev
Drill Hole Size	9,8 mm
Cutting Fluid	Water-Soluble Fluid

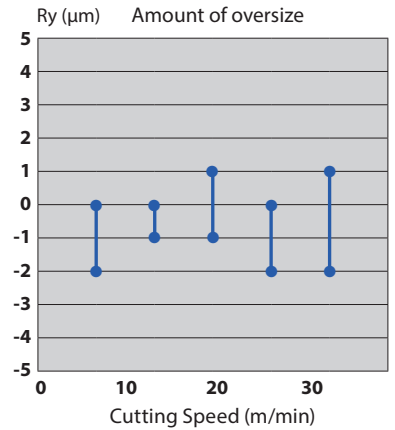
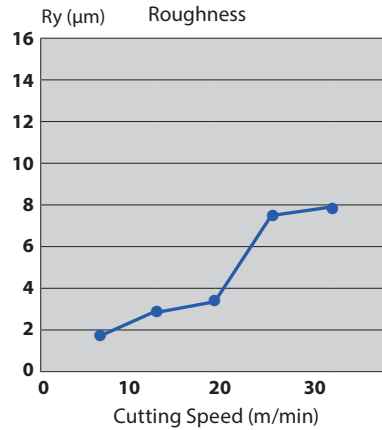

The surface roughness and amount of oversize at different feed rates per revolution

Cutting Conditions

Work Material	S50C (JIS S50C,AISI 1050)
Reamer Size	10 mm
Cutting Speed	15 m/min
Drill Hole Size	9,8 mm
Cutting Fluid	Water-Soluble Fluid

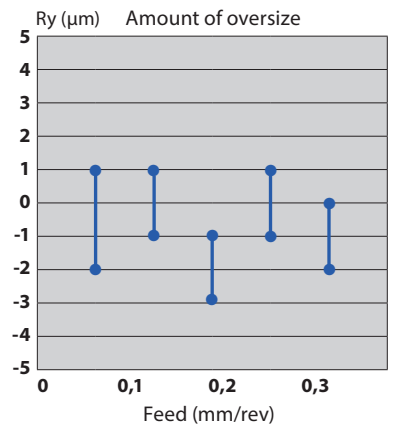
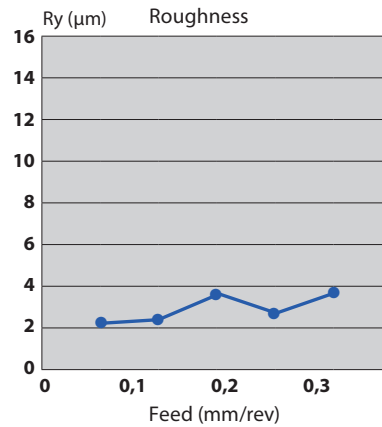

The surface roughness and amount of oversize at different cutting speeds

Cutting Conditions

Reamer Size	10 mm
Cutting Speed	15 m/min
Feed	0,2 mm/rev
Drill Hole Size	9,8 mm
Cutting Fluid	Water-Soluble Fluid

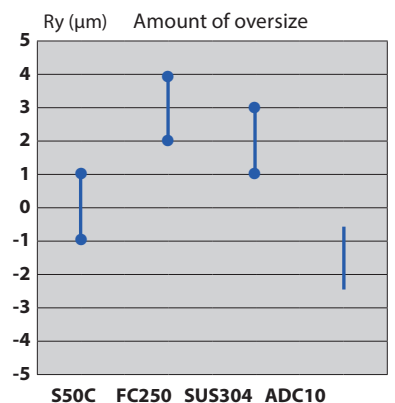
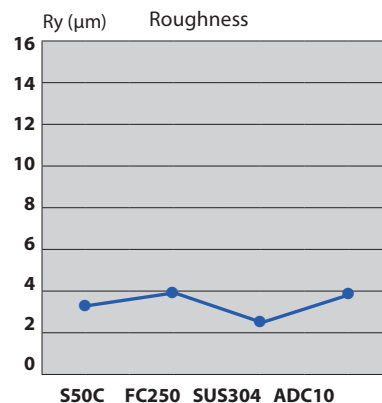

CUTTING DATA

Example of Circularity

Cutting Conditions

Work Material	S50C (JIS S50C,AISI 1050)
Reamer Size	10 mm
Cutting Speed	15 m/min
Feed	0,2 mm
Drill Hole Size	9,8 mm

The amount of over size was determined from the actual reamer size

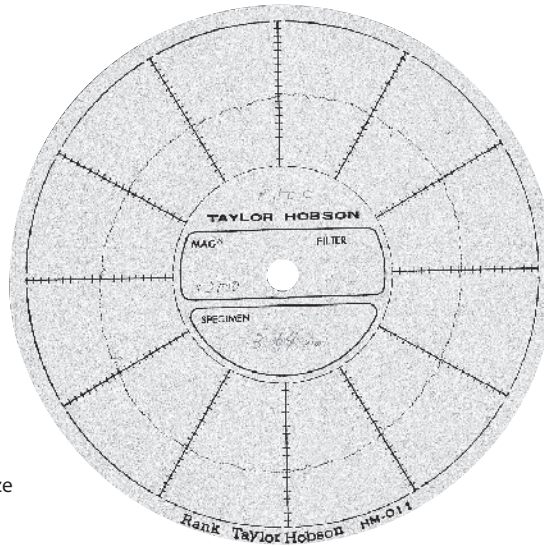

Magnification : X 2.000

Circularity : 3,64 µm

Cutting Conditions

Vc	Low Carbon Steel S15C・SS400 AISI11015		Carbon Steel S45C・S50C AISI1045・1050		Alloy Steel SCM・SNC・SNM		Alluminium Alloy A7075・ADC DIN ALZnMgCu1.5D	
	F (mm/rev.)	Removal Amount (mm)	F (mm/rev.)	Removal Amount (mm)	F (mm/rev.)	Removal Amount (mm)	F (mm/rev.)	Removal Amount (mm)
	12 ~ 20 m/min		10 ~ 16 m/min		8 ~ 12 m/min		15 ~ 30 m/min	
0,3	0,002~0,005	0,03~0,08	0,002~0,005	0,03~0,08	0,002~0,005	0,03~0,08	0,002~0,005	0,03~0,08
0,5	0,004~0,01	0,05~0,10	0,004~0,01	0,05~0,10	0,004~0,01	0,05~0,10	0,004~0,01	0,05~0,10
1	0,008~0,015	0,05~0,10	0,008~0,015	0,05~0,10	0,008~0,015	0,05~0,10	0,008~0,015	0,05~0,10
2	0,018~0,03	0,05~0,15	0,018~0,03	0,05~0,15	0,018~0,03	0,05~0,15	0,018~0,03	0,05~0,15
3	0,028~0,045	0,10~0,20	0,028~0,045	0,10~0,20	0,028~0,045	0,10~0,20	0,028~0,045	0,10~0,20
4	0,04~0,06	0,10~0,20	0,04~0,06	0,10~0,20	0,04~0,06	0,10~0,20	0,04~0,06	0,10~0,20
5	0,05~0,09	0,10~0,20	0,05~0,09	0,10~0,20	0,05~0,09	0,10~0,20	0,06~0,09	0,10~0,20
6	0,06~0,12	0,10~0,20	0,06~0,12	0,10~0,20	0,06~0,12	0,10~0,20	0,07~0,13	0,10~0,20
8	0,08~0,15	0,10~0,20	0,08~0,15	0,10~0,20	0,08~0,15	0,10~0,20	0,08~0,18	0,10~0,20
10	0,10~0,20	0,10~0,20	0,10~0,20	0,10~0,20	0,10~0,20	0,10~0,20	0,10~0,23	0,10~0,30
12	0,12~0,22	0,10~0,20	0,12~0,22	0,10~0,20	0,12~0,22	0,10~0,20	0,12~0,28	0,10~0,30
13	0,13~0,23	0,10~0,20	0,13~0,23	0,10~0,20	0,13~0,23	0,10~0,20	0,13~0,30	0,10~0,30

Vc	Hardened Steel SKT・SKD ~40HRC		~50 HRC		GG FC250		Copper C1100 DIN ECu57	
	F (mm/rev.)	Removal Amount (mm)	F (mm/rev.)	Removal Amount (mm)	F (mm/rev.)	Removal Amount (mm)	F (mm/rev.)	Removal Amount (mm)
	6 ~ 12 m/min		4 ~ 10 m/min		8 ~ 16 m/min		10 ~ 25 m/min	
0,3	0,001~0,004	0,03~0,08	-	-	0,002~0,005	0,03~0,08	0,002~0,005	0,03~0,08
0,5	0,003~0,009	0,05~0,10	-	-	0,004~0,01	0,05~0,10	0,004~0,01	0,05~0,10
1	0,007~0,014	0,05~0,10	-	-	0,008~0,015	0,05~0,10	0,008~0,015	0,05~0,10
2	0,015~0,027	0,05~0,15	-	-	0,018~0,03	0,05~0,15	0,018~0,03	0,05~0,15
3	0,023~0,04	0,10~0,20	0,012~0,03	0,03~0,08	0,028~0,045	0,10~0,20	0,028~0,045	0,10~0,20
4	0,032~0,052	0,10~0,20	0,015~0,035	0,03~0,08	0,04~0,06	0,10~0,20	0,04~0,06	0,10~0,20
5	0,04~0,08	0,10~0,20	0,02~0,05	0,03~0,08	0,05~0,09	0,10~0,20	0,05~0,09	0,10~0,20
6	0,05~0,10	0,10~0,20	0,025~0,055	0,03~0,08	0,06~0,12	0,10~0,20	0,06~0,12	0,10~0,20
8	0,06~0,13	0,10~0,20	0,03~0,075	0,03~0,08	0,08~0,15	0,10~0,20	0,08~0,15	0,10~0,20
10	0,08~0,18	0,10~0,20	0,04~0,08	0,03~0,08	0,10~0,20	0,10~0,20	0,10~0,20	0,10~0,20
12	0,10~0,20	0,10~0,20	0,04~0,09	0,03~0,08	0,12~0,23	0,10~0,20	0,12~0,23	0,10~0,20
13	0,10~0,21	0,10~0,20	0,04~0,10	0,03~0,08	0,13~0,25	0,10~0,20	0,13~0,25	0,10~0,20



- First choice in quality and performance
- Carbide straight reamer, bright finish
- From \varnothing 0,3- 13,05 mm in 0,01 mm increments
- 1276 sizes

Type 1

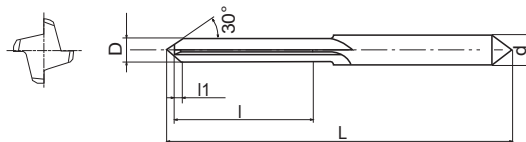

Type 2

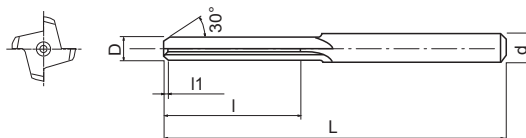

Type 3

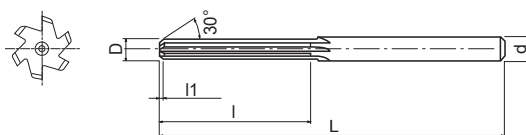

EDP	D	L	l	l1	d	z	Type	Price
8900030	0,3	50	4	0,1	2	4	1	
8900031	0,31	50	4	0,1	2	4	1	
8900032	0,32	50	4	0,1	2	4	1	
8900033	0,33	50	4	0,1	2	4	1	
8900034	0,34	50	4	0,1	2	4	1	
8900035	0,35	50	4	0,1	2	4	1	
8900036	0,36	50	4	0,1	2	4	1	
8900037	0,37	50	4	0,1	2	4	1	
8900038	0,38	50	4	0,1	2	4	1	
8900039	0,39	50	4	0,1	2	4	1	
8900040	0,4	50	4	0,1	2	4	1	
8900041	0,41	50	4	0,1	2	4	1	
8900042	0,42	50	4	0,1	2	4	1	
8900043	0,43	50	4	0,1	2	4	1	
8900044	0,44	50	4	0,1	2	4	1	
8900045	0,45	50	4	0,1	2	4	1	
8900046	0,46	50	4	0,1	2	4	1	
8900047	0,47	50	4	0,1	2	4	1	
8900048	0,48	50	5	0,1	2	4	1	
8900049	0,49	50	5	0,1	2	4	1	
8900050	0,5	50	5	0,1	2	4	1	
8900051	0,51	50	5	0,1	2	4	1	
8900052	0,52	50	5	0,1	2	4	1	
8900053	0,53	50	5	0,1	2	4	1	
8900054	0,54	50	6	0,1	2	4	1	
8900055	0,55	50	6	0,1	2	4	1	
8900056	0,56	50	6	0,1	2	4	1	
8900057	0,57	50	6	0,1	2	4	1	
8900058	0,58	50	6	0,1	2	4	1	
8900059	0,59	50	6	0,1	2	4	1	
8900060	0,6	50	6	0,1	2	4	1	
8900061	0,61	50	8	0,1	2	4	1	
8900062	0,62	50	8	0,1	2	4	1	
8900063	0,63	50	8	0,1	2	4	1	
8900064	0,64	50	8	0,1	2	4	1	
8900065	0,65	50	8	0,1	2	4	1	
8900066	0,66	50	8	0,1	2	4	1	
8900067	0,67	50	8	0,1	2	4	1	
8900068	0,68	50	10	0,1	2	4	1	
8900069	0,69	50	10	0,1	2	4	1	
8900070	0,7	50	10	0,1	2	4	1	
8900071	0,71	50	10	0,1	2	4	1	
8900072	0,72	50	10	0,1	2	4	1	
8900073	0,73	50	10	0,1	2	4	1	
8900074	0,74	50	10	0,1	2	4	1	

EDP	D	L	l	l1	d	z	Type	Price
8900075	0,75	50	10	0,1	2	4	1	
8900076	0,76	50	12	0,1	2	4	1	
8900077	0,77	50	12	0,1	2	4	1	
8900078	0,78	50	12	0,1	2	4	1	
8900079	0,79	50	12	0,1	2	4	1	
8900080	0,8	50	12	0,1	2	4	1	
8900081	0,81	50	12	0,2	2	4	1	
8900082	0,82	50	12	0,2	2	4	1	
8900083	0,83	50	12	0,2	2	4	1	
8900084	0,84	50	12	0,2	2	4	1	
8900085	0,85	50	12	0,2	2	4	1	
8900086	0,86	50	12	0,2	2	4	1	
8900087	0,87	50	12	0,2	2	4	1	
8900088	0,88	50	12	0,2	2	4	1	
8900089	0,89	50	12	0,2	2	4	1	
8900090	0,9	50	12	0,2	2	4	1	
8900091	0,91	50	12	0,2	2	4	1	
8900092	0,92	50	12	0,2	2	4	1	
8900093	0,93	50	12	0,2	2	4	1	
8900094	0,94	50	12	0,2	2	4	1	
8900095	0,95	50	12	0,2	2	4	1	
8900096	0,96	50	14	0,2	2	4	1	
8900097	0,97	50	14	0,2	2	4	1	
8900098	0,98	50	14	0,2	2	4	1	
8900099	0,99	50	14	0,2	2	4	1	
8900100	1	50	14	0,2	2	4	1	
8900101	1,01	50	14	0,2	2	4	1	
8900102	1,02	50	14	0,2	2	4	1	
8900103	1,03	50	14	0,2	2	4	1	
8900104	1,04	50	14	0,2	2	4	1	
8900105	1,05	50	14	0,2	2	4	1	
8900106	1,06	50	14	0,2	2	4	1	
8900107	1,07	50	14	0,2	2	4	1	
8900108	1,08	50	14	0,2	2	4	1	
8900109	1,09	50	14	0,2	2	4	1	
8900110	1,1	50	14	0,2	2	4	1	
8900111	1,11	50	14	0,2	2	4	1	
8900112	1,12	50	14	0,2	2	4	1	
8900113	1,13	50	14	0,2	2	4	1	
8900114	1,14	50	14	0,2	2	4	1	
8900115	1,15	50	14	0,2	2	4	1	
8900116	1,16	50	14	0,2	2	4	1	
8900117	1,17	50	14	0,2	2	4	1	
8900118	1,18	50	14	0,2	2	4	1	
8900119	1,19	50	16	0,2	2	4	1	





Type 1

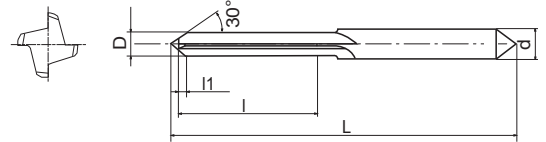

Type 2

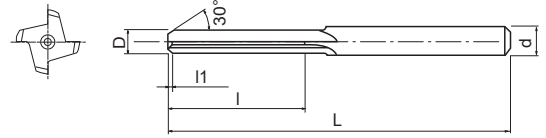

Type 3

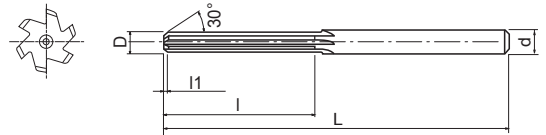

- First choice in quality and performance
- Carbide straight reamer, bright finish
- From $\varnothing 0,3$ - 13,05 mm in 0,01 mm increments
- 1276 sizes

P C: $\leq 0,2\%$	P C: 0,25-0,4%	P C: $\geq 0,45\%$	P SCM	K GG	N Al	N AC,ADC	H 25-35 HRC	H 35-45 HRC	H 45-52 HRC
-----------------------------	--------------------------	------------------------------	-----------------	----------------	----------------	--------------------	-----------------------	-----------------------	-----------------------

CARBIDE	$0 \sim +0,005$	h6
----------------	-----------------	-----------

Carbide reamers

EDP	D	L	l	l1	d	z	Type	Price
8900120	1,2	50	16	0,2	2	4	1	
8900121	1,21	50	16	0,2	2	4	1	
8900122	1,22	50	16	0,2	2	4	1	
8900123	1,23	50	16	0,2	2	4	1	
8900124	1,24	50	16	0,2	2	4	1	
8900125	1,25	50	16	0,2	2	4	1	
8900126	1,26	50	16	0,3	2	4	1	
8900127	1,27	50	16	0,3	2	4	1	
8900128	1,28	50	16	0,3	2	4	1	
8900129	1,29	50	16	0,3	2	4	1	
8900130	1,3	50	16	0,3	2	4	1	
8900131	1,31	50	16	0,3	2	4	1	
8900132	1,32	50	16	0,3	2	4	1	
8900133	1,33	50	16	0,3	2	4	1	
8900134	1,34	50	16	0,3	2	4	1	
8900135	1,35	50	16	0,3	2	4	1	
8900136	1,36	50	16	0,3	2	4	1	
8900137	1,37	50	16	0,3	2	4	1	
8900138	1,38	50	16	0,3	2	4	1	
8900139	1,39	50	16	0,3	2	4	1	
8900140	1,4	50	16	0,3	2	4	1	
8900141	1,41	50	16	0,3	2	4	1	
8900142	1,42	50	16	0,3	2	4	1	
8900143	1,43	50	16	0,3	2	4	1	
8900144	1,44	50	16	0,3	2	4	1	
8900145	1,45	50	16	0,3	2	4	1	
8900146	1,46	50	16	0,3	2	4	1	
8900147	1,47	50	16	0,3	2	4	1	
8900148	1,48	50	16	0,3	2	4	1	
8900149	1,49	50	16	0,3	2	4	1	
8900150	1,5	50	16	0,3	2	4	1	
8900151	1,51	50	18	0,3	2	4	1	
8900152	1,52	50	18	0,3	2	4	1	
8900153	1,53	50	18	0,3	2	4	1	
8900154	1,54	50	18	0,3	2	4	1	
8900155	1,55	50	18	0,3	2	4	1	
8900156	1,56	50	18	0,3	2	4	1	
8900157	1,57	50	18	0,3	2	4	1	
8900158	1,58	50	18	0,3	2	4	1	
8900159	1,59	50	18	0,3	2	4	1	
8900160	1,6	50	18	0,3	2	4	1	
8900161	1,61	50	18	0,4	2	4	1	
8900162	1,62	50	18	0,4	2	4	1	
8900163	1,63	50	18	0,4	2	4	1	
8900164	1,64	50	18	0,4	2	4	1	

EDP	D	L	l	l1	d	z	Type	Price
8900165	1,65	50	18	0,4	2	4	1	
8900166	1,66	50	18	0,4	2	4	1	
8900167	1,67	50	18	0,4	2	4	1	
8900168	1,68	50	18	0,4	2	4	1	
8900169	1,69	50	18	0,4	2	4	1	
8900170	1,7	50	18	0,4	2	4	1	
8900171	1,71	50	18	0,4	2	4	1	
8900172	1,72	50	18	0,4	2	4	1	
8900173	1,73	50	18	0,4	2	4	1	
8900174	1,74	50	18	0,4	2	4	1	
8900175	1,75	50	18	0,4	2	4	1	
8900176	1,76	50	18	0,4	2	4	1	
8900177	1,77	50	18	0,4	2	4	1	
8900178	1,78	50	18	0,4	2	4	1	
8900179	1,79	50	18	0,4	2	4	1	
8900180	1,8	50	18	0,4	2	4	1	
8900181	1,81	50	18	0,4	2	4	1	
8900182	1,82	50	18	0,4	2	4	1	
8900183	1,83	50	18	0,4	2	4	1	
8900184	1,84	50	18	0,4	2	4	1	
8900185	1,85	50	18	0,4	2	4	1	
8900186	1,86	50	18	0,4	2	4	1	
8900187	1,87	50	18	0,4	2	4	1	
8900188	1,88	50	18	0,4	2	4	1	
8900189	1,89	50	18	0,4	2	4	1	
8900190	1,9	50	18	0,4	2	4	1	
8900191	1,91	50	20	0,4	2	4	1	
8900192	1,92	50	20	0,4	2	4	1	
8900193	1,93	50	20	0,4	2	4	1	
8900194	1,94	50	20	0,4	2	4	1	
8900195	1,95	50	20	0,4	2	4	1	
8900196	1,96	50	20	0,4	2	4	1	
8900197	1,97	50	20	0,4	2	4	1	
8900198	1,98	50	20	0,4	2	4	1	
8900199	1,99	50	20	0,4	2	4	1	
8900200	2	50	20	0,4	2	4	1	
8900201	2,01	50	20	0,5	2,5	4	1	
8900202	2,02	50	20	0,5	2,5	4	1	
8900203	2,03	50	20	0,5	2,5	4	1	
8900204	2,04	50	20	0,5	2,5	4	1	
8900205	2,05	50	20	0,5	2,5	4	1	
8900206	2,06	50	20	0,5	2,5	4	1	
8900207	2,07	50	20	0,5	2,5	4	1	
8900208	2,08	50	20	0,5	2,5	4	1	
8900209	2,09	50	20	0,5	2,5	4	1	



Type 1

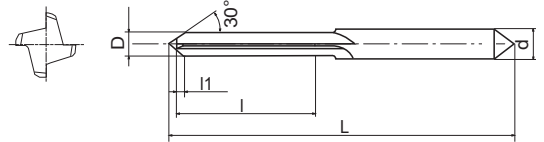

Type 2

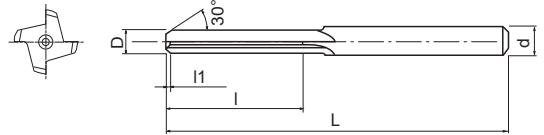

Type 3

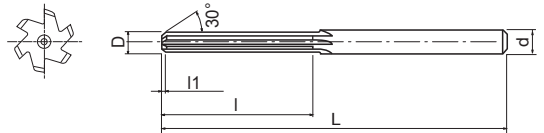

- First choice in quality and performance
- Carbide straight reamer, bright finish
- From Ø 0,3- 13,05 mm in 0,01 mm increments
- 1276 sizes

P C: ≤0,2%	P C: 0,25-0,4%	P C: ≥0,45%	P SCM	K GG	N Al	N AC,ADC	H 25-35 HRC	H 35-45 HRC	H 45-52 HRC
----------------------	--------------------------	-----------------------	-----------------	----------------	----------------	--------------------	-----------------------	-----------------------	-----------------------

CARBIDE

0~+0.005

h6

EDP	D	L	l	l1	d	z	Type	Price
8900210	2,1	50	20	0,5	2,5	4	1	
8900211	2,11	50	20	0,5	2,5	4	1	
8900212	2,12	50	20	0,5	2,5	4	1	
8900213	2,13	50	20	0,5	2,5	4	1	
8900214	2,14	50	20	0,5	2,5	4	1	
8900215	2,15	50	20	0,5	2,5	4	1	
8900216	2,16	50	20	0,5	2,5	4	1	
8900217	2,17	50	20	0,5	2,5	4	1	
8900218	2,18	50	20	0,5	2,5	4	1	
8900219	2,19	50	20	0,5	2,5	4	1	
8900220	2,2	50	20	0,5	2,5	4	1	
8900221	2,21	50	20	0,5	2,5	4	1	
8900222	2,22	50	20	0,5	2,5	4	1	
8900223	2,23	50	20	0,5	2,5	4	1	
8900224	2,24	50	20	0,5	2,5	4	1	
8900225	2,25	50	20	0,5	2,5	4	1	
8900226	2,26	50	20	0,5	2,5	4	1	
8900227	2,27	50	20	0,5	2,5	4	1	
8900228	2,28	50	20	0,5	2,5	4	1	
8900229	2,29	50	20	0,5	2,5	4	1	
8900230	2,3	50	20	0,5	2,5	4	1	
8900231	2,31	50	20	0,5	2,5	4	1	
8900232	2,32	50	20	0,5	2,5	4	1	
8900233	2,33	50	20	0,5	2,5	4	1	
8900234	2,34	50	20	0,5	2,5	4	1	
8900235	2,35	50	20	0,5	2,5	4	1	
8900236	2,36	50	20	0,5	2,5	4	1	
8900237	2,37	50	22	0,5	2,5	4	1	
8900238	2,38	50	22	0,5	2,5	4	1	
8900239	2,39	50	22	0,5	2,5	4	1	
8900240	2,4	50	22	0,5	2,5	4	1	
8900241	2,41	50	22	0,5	2,5	4	1	
8900242	2,42	50	22	0,5	2,5	4	1	
8900243	2,43	50	22	0,5	2,5	4	1	
8900244	2,44	50	22	0,5	2,5	4	1	
8900245	2,45	50	22	0,5	2,5	4	1	
8900246	2,46	50	22	0,5	2,5	4	1	
8900247	2,47	50	22	0,5	2,5	4	1	
8900248	2,48	50	22	0,5	2,5	4	1	
8900249	2,49	50	22	0,5	2,5	4	1	
8900250	2,5	50	22	0,5	2,5	4	1	
8900251	2,51	60	22	0,6	3	4	1	
8900252	2,52	60	22	0,6	3	4	1	
8900253	2,53	60	22	0,6	3	4	1	
8900254	2,54	60	22	0,6	3	4	1	

EDP	D	L	l	l1	d	z	Type	Price
8900255	2,55	60	22	0,6	3	4	1	
8900256	2,56	60	22	0,6	3	4	1	
8900257	2,57	60	22	0,6	3	4	1	
8900258	2,58	60	22	0,6	3	4	1	
8900259	2,59	60	22	0,6	3	4	1	
8900260	2,6	60	22	0,6	3	4	1	
8900261	2,61	60	22	0,6	3	4	1	
8900262	2,62	60	22	0,6	3	4	1	
8900263	2,63	60	22	0,6	3	4	1	
8900264	2,64	60	22	0,6	3	4	1	
8900265	2,65	60	22	0,6	3	4	1	
8900266	2,66	60	22	0,6	3	4	1	
8900267	2,67	60	22	0,6	3	4	1	
8900268	2,68	60	22	0,6	3	4	1	
8900269	2,69	60	22	0,6	3	4	1	
8900270	2,7	60	22	0,6	3	4	1	
8900271	2,71	60	22	0,6	3	4	1	
8900272	2,72	60	22	0,6	3	4	1	
8900273	2,73	60	22	0,6	3	4	1	
8900274	2,74	60	22	0,6	3	4	1	
8900275	2,75	60	22	0,6	3	4	1	
8900276	2,76	60	22	0,6	3	4	1	
8900277	2,77	60	22	0,6	3	4	1	
8900278	2,78	60	22	0,6	3	4	1	
8900279	2,79	60	22	0,6	3	4	1	
8900280	2,8	60	22	0,6	3	4	1	
8900281	2,81	60	25	0,6	3	4	1	
8900282	2,82	60	25	0,6	3	4	1	
8900283	2,83	60	25	0,6	3	4	1	
8900284	2,84	60	25	0,6	3	4	1	
8900285	2,85	60	25	0,6	3	4	1	
8900286	2,86	60	25	0,6	3	4	1	
8900287	2,87	60	25	0,6	3	4	1	
8900288	2,88	60	25	0,6	3	4	1	
8900289	2,89	60	25	0,6	3	4	1	
8900290	2,9	60	25	0,6	3	4	1	
8900291	2,91	60	25	0,6	3	4	1	
8900292	2,92	60	25	0,6	3	4	1	
8900293	2,93	60	25	0,6	3	4	1	
8900294	2,94	60	25	0,6	3	4	1	
8900295	2,95	60	25	0,6	3	4	1	
8900296	2,96	60	25	0,6	3	4	1	
8900297	2,97	60	25	0,6	3	4	1	
8900298	2,98	60	25	0,6	3	4	1	
8900299	2,99	60	25	0,6	3	4	1	





Type 1

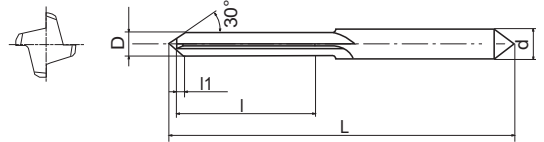

Type 2

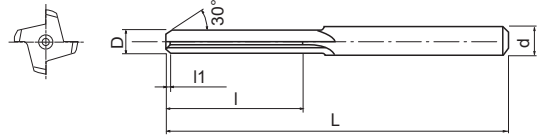

Type 3

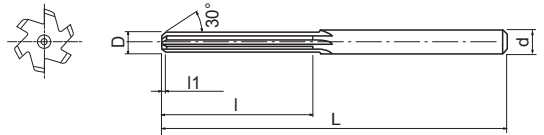

- First choice in quality and performance
- Carbide straight reamer, bright finish
- From Ø 0,3- 13,05 mm in 0,01 mm increments
- 1276 sizes

P C: ≤0,2%	P C: 0,25-0,4%	P C: ≥0,45%	P SCM	K GG	N Al	N AC,ADC	H 25-35 HRC	H 35-45 HRC	H 45-52 HRC
----------------------	--------------------------	-----------------------	-----------------	----------------	----------------	--------------------	-----------------------	-----------------------	-----------------------

CARBIDE
0~+0.005
h6

Carbide reamers

EDP	D	L	l	l1	d	z	Type	Price
8900300	3	60	25	0,6	3	4	1	
8900301	3,01	60	28	0,6	3,5	4	2	
8900302	3,02	60	28	0,6	3,5	4	2	
8900303	3,03	60	28	0,6	3,5	4	2	
8900304	3,04	60	28	0,6	3,5	4	2	
8900305	3,05	60	28	0,6	3,5	4	2	
8900306	3,06	60	28	0,6	3,5	4	2	
8900307	3,07	60	28	0,6	3,5	4	2	
8900308	3,08	60	28	0,6	3,5	4	2	
8900309	3,09	60	28	0,6	3,5	4	2	
8900310	3,1	60	28	0,6	3,5	4	2	
8900311	3,11	60	28	0,6	3,5	4	2	
8900312	3,12	60	28	0,6	3,5	4	2	
8900313	3,13	60	28	0,6	3,5	4	2	
8900314	3,14	60	28	0,6	3,5	4	2	
8900315	3,15	60	28	0,6	3,5	4	2	
8900316	3,16	60	28	0,8	3,5	4	2	
8900317	3,17	60	28	0,8	3,5	4	2	
8900318	3,18	60	28	0,8	3,5	4	2	
8900319	3,19	60	28	0,8	3,5	4	2	
8900320	3,2	60	28	0,8	3,5	4	2	
8900321	3,21	60	28	0,8	3,5	4	2	
8900322	3,22	60	28	0,8	3,5	4	2	
8900323	3,23	60	28	0,8	3,5	4	2	
8900324	3,24	60	28	0,8	3,5	4	2	
8900325	3,25	60	28	0,8	3,5	4	2	
8900326	3,26	60	28	0,8	3,5	4	2	
8900327	3,27	60	28	0,8	3,5	4	2	
8900328	3,28	60	28	0,8	3,5	4	2	
8900329	3,29	60	28	0,8	3,5	4	2	
8900330	3,3	60	28	0,8	3,5	4	2	
8900331	3,31	60	28	0,8	3,5	4	2	
8900332	3,32	60	28	0,8	3,5	4	2	
8900333	3,33	60	28	0,8	3,5	4	2	
8900334	3,34	60	28	0,8	3,5	4	2	
8900335	3,35	60	28	0,8	3,5	4	2	
8900336	3,36	60	28	0,8	3,5	4	2	
8900337	3,37	60	28	0,8	3,5	4	2	
8900338	3,38	60	28	0,8	3,5	4	2	
8900339	3,39	60	28	0,8	3,5	4	2	
8900340	3,4	60	28	0,8	3,5	4	2	
8900341	3,41	60	28	0,8	3,5	4	2	
8900342	3,42	60	28	0,8	3,5	4	2	
8900343	3,43	60	28	0,8	3,5	4	2	
8900344	3,44	60	28	0,8	3,5	4	2	

EDP	D	L	l	l1	d	z	Type	Price
8900345	3,45	60	28	0,8	3,5	4	2	
8900346	3,46	60	28	0,8	3,5	4	2	
8900347	3,47	60	28	0,8	3,5	4	2	
8900348	3,48	60	28	0,8	3,5	4	2	
8900349	3,49	60	28	0,8	3,5	4	2	
8900350	3,5	60	28	0,8	3,5	4	2	
8900351	3,51	70	28	0,8	4	4	2	
8900352	3,52	70	28	0,8	4	4	2	
8900353	3,53	70	28	0,8	4	4	2	
8900354	3,54	70	28	0,8	4	4	2	
8900355	3,55	70	28	0,8	4	4	2	
8900356	3,56	70	28	0,8	4	4	2	
8900357	3,57	70	28	0,8	4	4	2	
8900358	3,58	70	28	0,8	4	4	2	
8900359	3,59	70	28	0,8	4	4	2	
8900360	3,6	70	28	0,8	4	4	2	
8900361	3,61	70	28	0,8	4	4	2	
8900362	3,62	70	28	0,8	4	4	2	
8900363	3,63	70	28	0,8	4	4	2	
8900364	3,64	70	28	0,8	4	4	2	
8900365	3,65	70	28	0,8	4	4	2	
8900366	3,66	70	28	0,8	4	4	2	
8900367	3,67	70	28	0,8	4	4	2	
8900368	3,68	70	28	0,8	4	4	2	
8900369	3,69	70	28	0,8	4	4	2	
8900370	3,7	70	28	0,8	4	4	2	
8900371	3,71	70	28	0,8	4	4	2	
8900372	3,72	70	28	0,8	4	4	2	
8900373	3,73	70	28	0,8	4	4	2	
8900374	3,74	70	28	0,8	4	4	2	
8900375	3,75	70	28	0,8	4	4	2	
8900376	3,76	70	28	0,8	4	4	2	
8900377	3,77	70	28	0,8	4	4	2	
8900378	3,78	70	28	0,8	4	4	2	
8900379	3,79	70	28	0,8	4	4	2	
8900380	3,8	70	28	0,8	4	4	2	
8900381	3,81	70	28	0,8	4	4	2	
8900382	3,82	70	28	0,8	4	4	2	
8900383	3,83	70	28	0,8	4	4	2	
8900384	3,84	70	28	0,8	4	4	2	
8900385	3,85	70	28	0,8	4	4	2	
8900386	3,86	70	28	0,8	4	4	2	
8900387	3,87	70	28	0,8	4	4	2	
8900388	3,88	70	28	0,8	4	4	2	
8900389	3,89	70	28	0,8	4	4	2	



- First choice in quality and performance
- Carbide straight reamer, bright finish
- From Ø 0,3- 13,05 mm in 0,01 mm increments
- 1276 sizes

Type 1

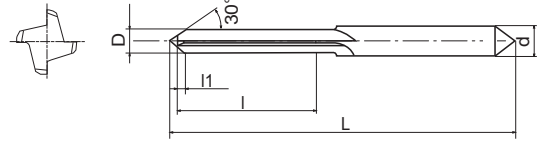

Type 2

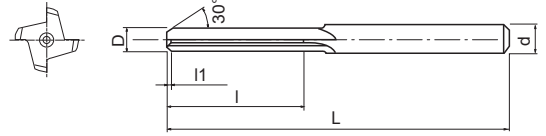

Type 3

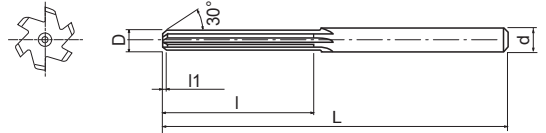

EDP	D	L	l	l1	d	z	Type	Price
8900390	3,9	70	28	0,8	4	4	2	
8900391	3,91	70	28	0,8	4	4	2	
8900392	3,92	70	28	0,8	4	4	2	
8900393	3,93	70	28	0,8	4	4	2	
8900394	3,94	70	28	0,8	4	4	2	
8900395	3,95	70	28	0,8	4	4	2	
8900396	3,96	70	28	0,8	4	4	2	
8900397	3,97	70	28	0,8	4	4	2	
8900398	3,98	70	28	0,8	4	4	2	
8900399	3,99	70	28	0,8	4	4	2	
8900400	4	70	28	0,8	4	4	2	
8900401	4,01	70	28	0,8	4,5	6	3	
8900402	4,02	70	28	0,8	4,5	6	3	
8900403	4,03	70	28	0,8	4,5	6	3	
8900404	4,04	70	28	0,8	4,5	6	3	
8900405	4,05	70	28	0,8	4,5	6	3	
8900406	4,06	70	28	0,8	4,5	6	3	
8900407	4,07	70	28	0,8	4,5	6	3	
8900408	4,08	70	28	0,8	4,5	6	3	
8900409	4,09	70	28	0,8	4,5	6	3	
8900410	4,1	70	28	0,8	4,5	6	3	
8900411	4,11	70	28	0,8	4,5	6	3	
8900412	4,12	70	28	0,8	4,5	6	3	
8900413	4,13	70	28	0,8	4,5	6	3	
8900414	4,14	70	28	0,8	4,5	6	3	
8900415	4,15	70	28	0,8	4,5	6	3	
8900416	4,16	70	28	0,8	4,5	6	3	
8900417	4,17	70	28	0,8	4,5	6	3	
8900418	4,18	70	28	0,8	4,5	6	3	
8900419	4,19	70	28	0,8	4,5	6	3	
8900420	4,2	70	28	0,8	4,5	6	3	
8900421	4,21	70	28	0,8	4,5	6	3	
8900422	4,22	70	28	0,8	4,5	6	3	
8900423	4,23	70	28	0,8	4,5	6	3	
8900424	4,24	70	28	0,8	4,5	6	3	
8900425	4,25	70	28	0,8	4,5	6	3	
8900426	4,26	70	28	0,8	4,5	6	3	
8900427	4,27	70	28	0,8	4,5	6	3	
8900428	4,28	70	28	0,8	4,5	6	3	
8900429	4,29	70	28	0,8	4,5	6	3	
8900430	4,3	70	28	0,8	4,5	6	3	
8900431	4,31	70	28	0,8	4,5	6	3	
8900432	4,32	70	28	0,8	4,5	6	3	
8900433	4,33	70	28	0,8	4,5	6	3	
8900434	4,34	70	28	0,8	4,5	6	3	

EDP	D	L	l	l1	d	z	Type	Price
8900435	4,35	70	28	0,8	4,5	6	3	
8900436	4,36	70	28	0,8	4,5	6	3	
8900437	4,37	70	28	0,8	4,5	6	3	
8900438	4,38	70	28	0,8	4,5	6	3	
8900439	4,39	70	28	0,8	4,5	6	3	
8900440	4,4	70	28	0,8	4,5	6	3	
8900441	4,41	70	28	0,8	4,5	6	3	
8900442	4,42	70	28	0,8	4,5	6	3	
8900443	4,43	70	28	0,8	4,5	6	3	
8900444	4,44	70	28	0,8	4,5	6	3	
8900445	4,45	70	28	0,8	4,5	6	3	
8900446	4,46	70	28	0,8	4,5	6	3	
8900447	4,47	70	28	0,8	4,5	6	3	
8900448	4,48	70	28	0,8	4,5	6	3	
8900449	4,49	70	28	0,8	4,5	6	3	
8900450	4,5	70	28	0,8	4,5	6	3	
8900451	4,51	80	28	0,8	5	6	3	
8900452	4,52	80	28	0,8	5	6	3	
8900453	4,53	80	28	0,8	5	6	3	
8900454	4,54	80	28	0,8	5	6	3	
8900455	4,55	80	28	0,8	5	6	3	
8900456	4,56	80	28	0,8	5	6	3	
8900457	4,57	80	28	0,8	5	6	3	
8900458	4,58	80	28	0,8	5	6	3	
8900459	4,59	80	28	0,8	5	6	3	
8900460	4,6	80	28	0,8	5	6	3	
8900461	4,61	80	28	0,8	5	6	3	
8900462	4,62	80	28	0,8	5	6	3	
8900463	4,63	80	28	0,8	5	6	3	
8900464	4,64	80	28	0,8	5	6	3	
8900465	4,65	80	28	0,8	5	6	3	
8900466	4,66	80	28	0,8	5	6	3	
8900467	4,67	80	28	0,8	5	6	3	
8900468	4,68	80	28	0,8	5	6	3	
8900469	4,69	80	28	0,8	5	6	3	
8900470	4,7	80	28	0,8	5	6	3	
8900471	4,71	80	28	0,8	5	6	3	
8900472	4,72	80	28	0,8	5	6	3	
8900473	4,73	80	28	0,8	5	6	3	
8900474	4,74	80	28	0,8	5	6	3	
8900475	4,75	80	28	0,8	5	6	3	
8900476	4,76	80	32	0,8	5	6	3	
8900477	4,77	80	32	0,8	5	6	3	
8900478	4,78	80	32	0,8	5	6	3	
8900479	4,79	80	32	0,8	5	6	3	





Type 1

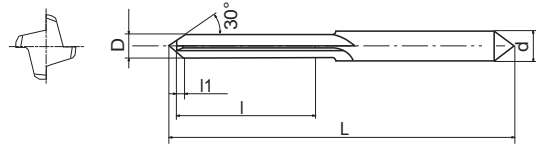

Type 2

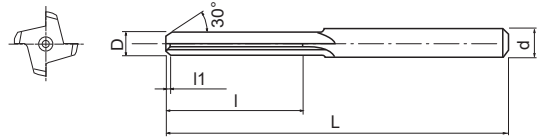

Type 3

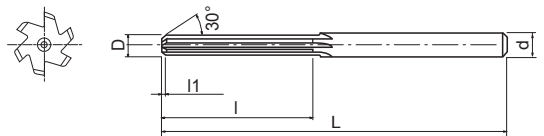

- First choice in quality and performance
- Carbide straight reamer, bright finish
- From Ø 0,3- 13,05 mm in 0,01 mm increments
- 1276 sizes

P C: ≤0,2%	P C: 0,25-0,4%	P C: ≥0,45%	P SCM	K GG	N Al	N AC,ADC	H 25-35 HRC	H 35-45 HRC	H 45-52 HRC
----------------------	--------------------------	-----------------------	-----------------	----------------	----------------	--------------------	-----------------------	-----------------------	-----------------------

CARBIDE
0~+0.005
h6

Carbide reamers

EDP	D	L	l	l1	d	z	Type	Price
8900480	4,8	80	32	0,8	5	6	3	
8900481	4,81	80	32	0,8	5	6	3	
8900482	4,82	80	32	0,8	5	6	3	
8900483	4,83	80	32	0,8	5	6	3	
8900484	4,84	80	32	0,8	5	6	3	
8900485	4,85	80	32	0,8	5	6	3	
8900486	4,86	80	32	0,8	5	6	3	
8900487	4,87	80	32	0,8	5	6	3	
8900488	4,88	80	32	0,8	5	6	3	
8900489	4,89	80	32	0,8	5	6	3	
8900490	4,9	80	32	0,8	5	6	3	
8900491	4,91	80	32	0,8	5	6	3	
8900492	4,92	80	32	0,8	5	6	3	
8900493	4,93	80	32	0,8	5	6	3	
8900494	4,94	80	32	0,8	5	6	3	
8900495	4,95	80	32	0,8	5	6	3	
8900496	4,96	80	32	0,8	5	6	3	
8900497	4,97	80	32	0,8	5	6	3	
8900498	4,98	80	32	0,8	5	6	3	
8900499	4,99	80	32	0,8	5	6	3	
8900500	5	80	32	0,8	5	6	3	
8900501	5,01	80	32	0,8	5,5	6	3	
8900502	5,02	80	32	0,8	5,5	6	3	
8900503	5,03	80	32	0,8	5,5	6	3	
8900504	5,04	80	32	0,8	5,5	6	3	
8900505	5,05	80	32	0,8	5,5	6	3	
8900506	5,06	80	32	0,8	5,5	6	3	
8900507	5,07	80	32	0,8	5,5	6	3	
8900508	5,08	80	32	0,8	5,5	6	3	
8900509	5,09	80	32	0,8	5,5	6	3	
8900510	5,1	80	32	0,8	5,5	6	3	
8900511	5,11	80	32	0,8	5,5	6	3	
8900512	5,12	80	32	0,8	5,5	6	3	
8900513	5,13	80	32	0,8	5,5	6	3	
8900514	5,14	80	32	0,8	5,5	6	3	
8900515	5,15	80	32	0,8	5,5	6	3	
8900516	5,16	80	32	0,8	5,5	6	3	
8900517	5,17	80	32	0,8	5,5	6	3	
8900518	5,18	80	32	0,8	5,5	6	3	
8900519	5,19	80	32	0,8	5,5	6	3	
8900520	5,2	80	32	0,8	5,5	6	3	
8900521	5,21	80	32	0,8	5,5	6	3	
8900522	5,22	80	32	0,8	5,5	6	3	
8900523	5,23	80	32	0,8	5,5	6	3	
8900524	5,24	80	32	0,8	5,5	6	3	

EDP	D	L	l	l1	d	z	Type	Price
8900525	5,25	80	32	0,8	5,5	6	3	
8900526	5,26	80	32	0,8	5,5	6	3	
8900527	5,27	80	32	0,8	5,5	6	3	
8900528	5,28	80	32	0,8	5,5	6	3	
8900529	5,29	80	32	0,8	5,5	6	3	
8900530	5,3	80	32	0,8	5,5	6	3	
8900531	5,31	80	32	0,8	5,5	6	3	
8900532	5,32	80	32	0,8	5,5	6	3	
8900533	5,33	80	32	0,8	5,5	6	3	
8900534	5,34	80	32	0,8	5,5	6	3	
8900535	5,35	80	32	0,8	5,5	6	3	
8900536	5,36	80	32	0,8	5,5	6	3	
8900537	5,37	80	32	0,8	5,5	6	3	
8900538	5,38	80	32	0,8	5,5	6	3	
8900539	5,39	80	32	0,8	5,5	6	3	
8900540	5,4	80	32	0,8	5,5	6	3	
8900541	5,41	80	32	0,8	5,5	6	3	
8900542	5,42	80	32	0,8	5,5	6	3	
8900543	5,43	80	32	0,8	5,5	6	3	
8900544	5,44	80	32	0,8	5,5	6	3	
8900545	5,45	80	32	0,8	5,5	6	3	
8900546	5,46	80	32	0,8	5,5	6	3	
8900547	5,47	80	32	0,8	5,5	6	3	
8900548	5,48	80	32	0,8	5,5	6	3	
8900549	5,49	80	32	0,8	5,5	6	3	
8900550	5,5	80	32	0,8	5,5	6	3	
8900551	5,51	80	32	0,8	6	6	3	
8900552	5,52	80	32	0,8	6	6	3	
8900553	5,53	80	32	0,8	6	6	3	
8900554	5,54	80	32	0,8	6	6	3	
8900555	5,55	80	32	0,8	6	6	3	
8900556	5,56	80	32	0,8	6	6	3	
8900557	5,57	80	32	0,8	6	6	3	
8900558	5,58	80	32	0,8	6	6	3	
8900559	5,59	80	32	0,8	6	6	3	
8900560	5,6	80	32	0,8	6	6	3	
8900561	5,61	80	32	0,8	6	6	3	
8900562	5,62	80	32	0,8	6	6	3	
8900563	5,63	80	32	0,8	6	6	3	
8900564	5,64	80	32	0,8	6	6	3	
8900565	5,65	80	32	0,8	6	6	3	
8900566	5,66	80	32	0,8	6	6	3	
8900567	5,67	80	32	0,8	6	6	3	
8900568	5,68	80	32	0,8	6	6	3	
8900569	5,69	80	32	0,8	6	6	3	



Type 1

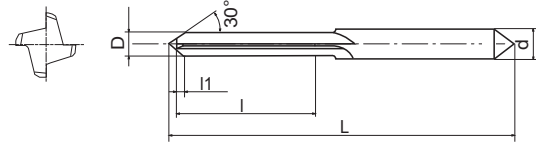

Type 2

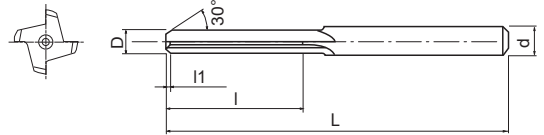

Type 3

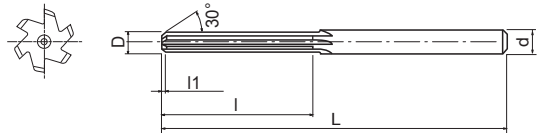

- First choice in quality and performance
- Carbide straight reamer, bright finish
- From Ø 0,3- 13,05 mm in 0,01 mm increments
- 1276 sizes

P C: ≤0,2%	P C: 0,25-0,4%	P C: ≥0,45%	P SCM	K GG	N Al	N AC,ADC	H 25-35 HRC	H 35-45 HRC	H 45-52 HRC
----------------------	--------------------------	-----------------------	-----------------	----------------	----------------	--------------------	-----------------------	-----------------------	-----------------------

CARBIDE

0~+0.005

h6

EDP	D	L	l	l1	d	z	Type	Price
8900570	5,7	80	32	0,8	6	6	3	
8900571	5,71	80	32	0,8	6	6	3	
8900572	5,72	80	32	0,8	6	6	3	
8900573	5,73	80	32	0,8	6	6	3	
8900574	5,74	80	32	0,8	6	6	3	
8900575	5,75	80	32	0,8	6	6	3	
8900576	5,76	80	32	0,8	6	6	3	
8900577	5,77	80	32	0,8	6	6	3	
8900578	5,78	80	32	0,8	6	6	3	
8900579	5,79	80	32	0,8	6	6	3	
8900580	5,8	80	32	0,8	6	6	3	
8900581	5,81	80	32	0,8	6	6	3	
8900582	5,82	80	32	0,8	6	6	3	
8900583	5,83	80	32	0,8	6	6	3	
8900584	5,84	80	32	0,8	6	6	3	
8900585	5,85	80	32	0,8	6	6	3	
8900586	5,86	80	32	0,8	6	6	3	
8900587	5,87	80	32	0,8	6	6	3	
8900588	5,88	80	32	0,8	6	6	3	
8900589	5,89	80	32	0,8	6	6	3	
8900590	5,9	80	32	0,8	6	6	3	
8900591	5,91	80	32	0,8	6	6	3	
8900592	5,92	80	32	0,8	6	6	3	
8900593	5,93	80	32	0,8	6	6	3	
8900594	5,94	80	32	0,8	6	6	3	
8900595	5,95	80	32	0,8	6	6	3	
8900596	5,96	80	32	0,8	6	6	3	
8900597	5,97	80	32	0,8	6	6	3	
8900598	5,98	80	32	0,8	6	6	3	
8900599	5,99	80	32	0,8	6	6	3	
8900600	6	80	32	0,8	6	6	3	
8900601	6,01	80	35	0,8	7	6	3	
8900602	6,02	80	35	0,8	7	6	3	
8900603	6,03	80	35	0,8	7	6	3	
8900604	6,04	80	35	0,8	7	6	3	
8900605	6,05	80	35	0,8	7	6	3	
8900606	6,06	80	35	0,8	7	6	3	
8900607	6,07	80	35	0,8	7	6	3	
8900608	6,08	80	35	0,8	7	6	3	
8900609	6,09	80	35	0,8	7	6	3	
8900610	6,1	80	35	0,8	7	6	3	
8900611	6,11	80	35	0,8	7	6	3	
8900612	6,12	80	35	0,8	7	6	3	
8900613	6,13	80	35	0,8	7	6	3	
8900614	6,14	80	35	0,8	7	6	3	

EDP	D	L	l	l1	d	z	Type	Price
8900615	6,15	80	35	0,8	7	6	3	
8900616	6,16	80	35	0,8	7	6	3	
8900617	6,17	80	35	0,8	7	6	3	
8900618	6,18	80	35	0,8	7	6	3	
8900619	6,19	80	35	0,8	7	6	3	
8900620	6,2	80	35	0,8	7	6	3	
8900621	6,21	80	35	0,8	7	6	3	
8900622	6,22	80	35	0,8	7	6	3	
8900623	6,23	80	35	0,8	7	6	3	
8900624	6,24	80	35	0,8	7	6	3	
8900625	6,25	80	35	0,8	7	6	3	
8900626	6,26	80	35	0,8	7	6	3	
8900627	6,27	80	35	0,8	7	6	3	
8900628	6,28	80	35	0,8	7	6	3	
8900629	6,29	80	35	0,8	7	6	3	
8900630	6,3	80	35	0,8	7	6	3	
8900631	6,31	80	35	0,8	7	6	3	
8900632	6,32	80	35	0,8	7	6	3	
8900633	6,33	80	35	0,8	7	6	3	
8900634	6,34	80	35	0,8	7	6	3	
8900635	6,35	80	35	0,8	7	6	3	
8900636	6,36	80	35	0,8	7	6	3	
8900637	6,37	80	35	0,8	7	6	3	
8900638	6,38	80	35	0,8	7	6	3	
8900639	6,39	80	35	0,8	7	6	3	
8900640	6,4	80	35	0,8	7	6	3	
8900641	6,41	80	35	0,8	7	6	3	
8900642	6,42	80	35	0,8	7	6	3	
8900643	6,43	80	35	0,8	7	6	3	
8900644	6,44	80	35	0,8	7	6	3	
8900645	6,45	80	35	0,8	7	6	3	
8900646	6,46	80	35	0,8	7	6	3	
8900647	6,47	80	35	0,8	7	6	3	
8900648	6,48	80	35	0,8	7	6	3	
8900649	6,49	80	35	0,8	7	6	3	
8900650	6,5	80	35	0,8	7	6	3	
8900651	6,51	80	35	0,8	7	6	3	
8900652	6,52	80	35	0,8	7	6	3	
8900653	6,53	80	35	0,8	7	6	3	
8900654	6,54	80	35	0,8	7	6	3	
8900655	6,55	80	35	0,8	7	6	3	
8900656	6,56	80	35	0,8	7	6	3	
8900657	6,57	80	35	0,8	7	6	3	
8900658	6,58	80	35	0,8	7	6	3	
8900659	6,59	80	35	0,8	7	6	3	





Type 1

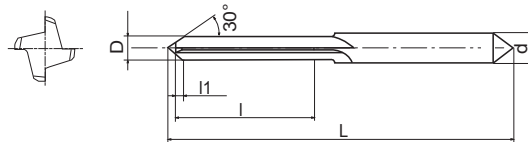

Type 2

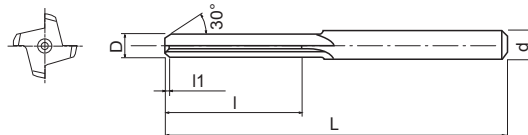

Type 3

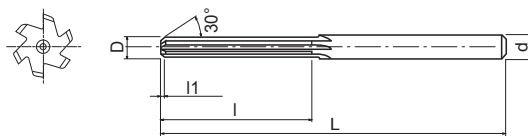

- First choice in quality and performance
- Carbide straight reamer, bright finish
- From $\varnothing 0,3$ - 13,05 mm in 0,01 mm increments
- 1276 sizes

P C: $\leq 0,2\%$	P C: 0,25-0,4%	P C: $\geq 0,45\%$	P SCM	K GG	N Al	N AC,ADC	H 25-35 HRC	H 35-45 HRC	H 45-52 HRC
-----------------------------	--------------------------	------------------------------	-----------------	----------------	----------------	--------------------	-----------------------	-----------------------	-----------------------

CARBIDE

0~+0.005

h6

EDP	D	L	l	l1	d	z	Type	Price
8900660	6,6	80	35	0,8	7	6	3	
8900661	6,61	80	35	0,8	7	6	3	
8900662	6,62	80	35	0,8	7	6	3	
8900663	6,63	80	35	0,8	7	6	3	
8900664	6,64	80	35	0,8	7	6	3	
8900665	6,65	80	35	0,8	7	6	3	
8900666	6,66	80	35	0,8	7	6	3	
8900667	6,67	80	35	0,8	7	6	3	
8900668	6,68	80	35	0,8	7	6	3	
8900669	6,69	80	35	0,8	7	6	3	
8900670	6,7	80	35	0,8	7	6	3	
8900671	6,71	80	35	0,8	7	6	3	
8900672	6,72	80	35	0,8	7	6	3	
8900673	6,73	80	35	0,8	7	6	3	
8900674	6,74	80	35	0,8	7	6	3	
8900675	6,75	80	35	0,8	7	6	3	
8900676	6,76	80	35	0,8	7	6	3	
8900677	6,77	80	35	0,8	7	6	3	
8900678	6,78	80	35	0,8	7	6	3	
8900679	6,79	80	35	0,8	7	6	3	
8900680	6,8	80	35	0,8	7	6	3	
8900681	6,81	80	35	0,8	7	6	3	
8900682	6,82	80	35	0,8	7	6	3	
8900683	6,83	80	35	0,8	7	6	3	
8900684	6,84	80	35	0,8	7	6	3	
8900685	6,85	80	35	0,8	7	6	3	
8900686	6,86	80	35	0,8	7	6	3	
8900687	6,87	80	35	0,8	7	6	3	
8900688	6,88	80	35	0,8	7	6	3	
8900689	6,89	80	35	0,8	7	6	3	
8900690	6,9	80	35	0,8	7	6	3	
8900691	6,91	80	35	0,8	7	6	3	
8900692	6,92	80	35	0,8	7	6	3	
8900693	6,93	80	35	0,8	7	6	3	
8900694	6,94	80	35	0,8	7	6	3	
8900695	6,95	80	35	0,8	7	6	3	
8900696	6,96	80	35	0,8	7	6	3	
8900697	6,97	80	35	0,8	7	6	3	
8900698	6,98	80	35	0,8	7	6	3	
8900699	6,99	80	35	0,8	7	6	3	
8900700	7	80	35	0,8	7	6	3	
8900701	7,01	90	35	0,8	8	6	3	
8900702	7,02	90	35	0,8	8	6	3	
8900703	7,03	90	35	0,8	8	6	3	
8900704	7,04	90	35	0,8	8	6	3	

EDP	D	L	l	l1	d	z	Type	Price
8900705	7,05	90	35	0,8	8	6	3	
8900706	7,06	90	35	0,8	8	6	3	
8900707	7,07	90	35	0,8	8	6	3	
8900708	7,08	90	35	0,8	8	6	3	
8900709	7,09	90	35	0,8	8	6	3	
8900710	7,1	90	35	0,8	8	6	3	
8900711	7,11	90	35	0,8	8	6	3	
8900712	7,12	90	35	0,8	8	6	3	
8900713	7,13	90	35	0,8	8	6	3	
8900714	7,14	90	35	0,8	8	6	3	
8900715	7,15	90	35	0,8	8	6	3	
8900716	7,16	90	35	0,8	8	6	3	
8900717	7,17	90	35	0,8	8	6	3	
8900718	7,18	90	35	0,8	8	6	3	
8900719	7,19	90	35	0,8	8	6	3	
8900720	7,2	90	35	0,8	8	6	3	
8900721	7,21	90	35	0,8	8	6	3	
8900722	7,22	90	35	0,8	8	6	3	
8900723	7,23	90	35	0,8	8	6	3	
8900724	7,24	90	35	0,8	8	6	3	
8900725	7,25	90	35	0,8	8	6	3	
8900726	7,26	90	35	0,8	8	6	3	
8900727	7,27	90	35	0,8	8	6	3	
8900728	7,28	90	35	0,8	8	6	3	
8900729	7,29	90	35	0,8	8	6	3	
8900730	7,3	90	35	0,8	8	6	3	
8900731	7,31	90	35	0,8	8	6	3	
8900732	7,32	90	35	0,8	8	6	3	
8900733	7,33	90	35	0,8	8	6	3	
8900734	7,34	90	35	0,8	8	6	3	
8900735	7,35	90	35	0,8	8	6	3	
8900736	7,36	90	35	0,8	8	6	3	
8900737	7,37	90	35	0,8	8	6	3	
8900738	7,38	90	35	0,8	8	6	3	
8900739	7,39	90	35	0,8	8	6	3	
8900740	7,4	90	35	0,8	8	6	3	
8900741	7,41	90	35	0,8	8	6	3	
8900742	7,42	90	35	0,8	8	6	3	
8900743	7,43	90	35	0,8	8	6	3	
8900744	7,44	90	35	0,8	8	6	3	
8900745	7,45	90	35	0,8	8	6	3	
8900746	7,46	90	35	0,8	8	6	3	
8900747	7,47	90	35	0,8	8	6	3	
8900748	7,48	90	35	0,8	8	6	3	
8900749	7,49	90	35	0,8	8	6	3	



Type 1

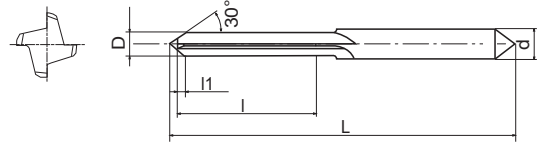

Type 2

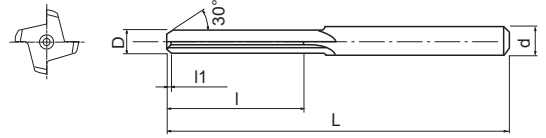

Type 3

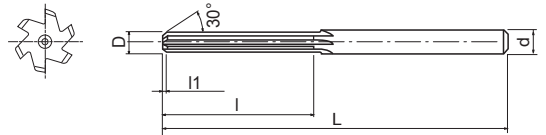

- First choice in quality and performance
- Carbide straight reamer, bright finish
- From Ø 0,3- 13,05 mm in 0,01 mm increments
- 1276 sizes

P C: ≤0,2%	P C: 0,25-0,4%	P C: ≥0,45%	P SCM	K GG	N Al	N AC,ADC	H 25-35 HRC	H 35-45 HRC	H 45-52 HRC
----------------------	--------------------------	-----------------------	-----------------	----------------	----------------	--------------------	-----------------------	-----------------------	-----------------------

CARBIDE	0~+0.005	h6
----------------	----------	-----------

EDP	D	L	l	l1	d	z	Type	Price
8900750	7,5	90	35	0,8	8	6	3	
8900751	7,51	90	40	0,8	8	6	3	
8900752	7,52	90	40	0,8	8	6	3	
8900753	7,53	90	40	0,8	8	6	3	
8900754	7,54	90	40	0,8	8	6	3	
8900755	7,55	90	40	0,8	8	6	3	
8900756	7,56	90	40	0,8	8	6	3	
8900757	7,57	90	40	0,8	8	6	3	
8900758	7,58	90	40	0,8	8	6	3	
8900759	7,59	90	40	0,8	8	6	3	
8900760	7,6	90	40	0,8	8	6	3	
8900761	7,61	90	40	0,8	8	6	3	
8900762	7,62	90	40	0,8	8	6	3	
8900763	7,63	90	40	0,8	8	6	3	
8900764	7,64	90	40	0,8	8	6	3	
8900765	7,65	90	40	0,8	8	6	3	
8900766	7,66	90	40	0,8	8	6	3	
8900767	7,67	90	40	0,8	8	6	3	
8900768	7,68	90	40	0,8	8	6	3	
8900769	7,69	90	40	0,8	8	6	3	
8900770	7,7	90	40	0,8	8	6	3	
8900771	7,71	90	40	0,8	8	6	3	
8900772	7,72	90	40	0,8	8	6	3	
8900773	7,73	90	40	0,8	8	6	3	
8900774	7,74	90	40	0,8	8	6	3	
8900775	7,75	90	40	0,8	8	6	3	
8900776	7,76	90	40	0,8	8	6	3	
8900777	7,77	90	40	0,8	8	6	3	
8900778	7,78	90	40	0,8	8	6	3	
8900779	7,79	90	40	0,8	8	6	3	
8900780	7,8	90	40	0,8	8	6	3	
8900781	7,81	90	40	0,8	8	6	3	
8900782	7,82	90	40	0,8	8	6	3	
8900783	7,83	90	40	0,8	8	6	3	
8900784	7,84	90	40	0,8	8	6	3	
8900785	7,85	90	40	0,8	8	6	3	
8900786	7,86	90	40	0,8	8	6	3	
8900787	7,87	90	40	0,8	8	6	3	
8900788	7,88	90	40	0,8	8	6	3	
8900789	7,89	90	40	0,8	8	6	3	
8900790	7,9	90	40	0,8	8	6	3	
8900791	7,91	90	40	0,8	8	6	3	
8900792	7,92	90	40	0,8	8	6	3	
8900793	7,93	90	40	0,8	8	6	3	
8900794	7,94	90	40	0,8	8	6	3	

EDP	D	L	l	l1	d	z	Type	Price
8900795	7,95	90	40	0,8	8	6	3	
8900796	7,96	90	40	0,8	8	6	3	
8900797	7,97	90	40	0,8	8	6	3	
8900798	7,98	90	40	0,8	8	6	3	
8900799	7,99	90	40	0,8	8	6	3	
8900800	8	90	40	0,8	8	6	3	
8900801	8,01	90	40	1	9	6	3	
8900802	8,02	90	40	1	9	6	3	
8900803	8,03	90	40	1	9	6	3	
8900804	8,04	90	40	1	9	6	3	
8900805	8,05	90	40	1	9	6	3	
8900806	8,06	90	40	1	9	6	3	
8900807	8,07	90	40	1	9	6	3	
8900808	8,08	90	40	1	9	6	3	
8900809	8,09	90	40	1	9	6	3	
8900810	8,1	90	40	1	9	6	3	
8900811	8,11	90	40	1	9	6	3	
8900812	8,12	90	40	1	9	6	3	
8900813	8,13	90	40	1	9	6	3	
8900814	8,14	90	40	1	9	6	3	
8900815	8,15	90	40	1	9	6	3	
8900816	8,16	90	40	1	9	6	3	
8900817	8,17	90	40	1	9	6	3	
8900818	8,18	90	40	1	9	6	3	
8900819	8,19	90	40	1	9	6	3	
8900820	8,2	90	40	1	9	6	3	
8900821	8,21	90	40	1	9	6	3	
8900822	8,22	90	40	1	9	6	3	
8900823	8,23	90	40	1	9	6	3	
8900824	8,24	90	40	1	9	6	3	
8900825	8,25	90	40	1	9	6	3	
8900826	8,26	90	40	1	9	6	3	
8900827	8,27	90	40	1	9	6	3	
8900828	8,28	90	40	1	9	6	3	
8900829	8,29	90	40	1	9	6	3	
8900830	8,3	90	40	1	9	6	3	
8900831	8,31	90	40	1	9	6	3	
8900832	8,32	90	40	1	9	6	3	
8900833	8,33	90	40	1	9	6	3	
8900834	8,34	90	40	1	9	6	3	
8900835	8,35	90	40	1	9	6	3	
8900836	8,36	90	40	1	9	6	3	
8900837	8,37	90	40	1	9	6	3	
8900838	8,38	90	40	1	9	6	3	
8900839	8,39	90	40	1	9	6	3	





- First choice in quality and performance
- Carbide straight reamer, bright finish
- From $\varnothing 0,3$ - 13,05 mm in 0,01 mm increments
- 1276 sizes

Type 1

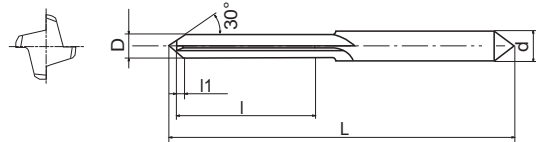

Type 2

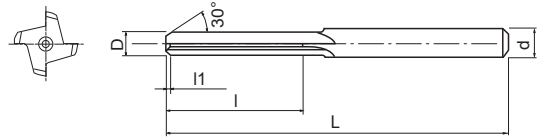

Type 3

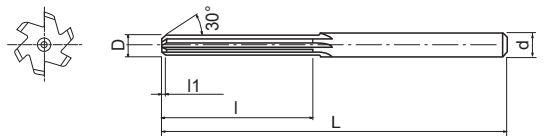

EDP	D	L	l	l1	d	z	Type	Price
8900840	8,4	90	40	1	9	6	3	
8900841	8,41	90	40	1	9	6	3	
8900842	8,42	90	40	1	9	6	3	
8900843	8,43	90	40	1	9	6	3	
8900844	8,44	90	40	1	9	6	3	
8900845	8,45	90	40	1	9	6	3	
8900846	8,46	90	40	1	9	6	3	
8900847	8,47	90	40	1	9	6	3	
8900848	8,48	90	40	1	9	6	3	
8900849	8,49	90	40	1	9	6	3	
8900850	8,5	90	40	1	9	6	3	
8900851	8,51	90	40	1	9	6	3	
8900852	8,52	90	40	1	9	6	3	
8900853	8,53	90	40	1	9	6	3	
8900854	8,54	90	40	1	9	6	3	
8900855	8,55	90	40	1	9	6	3	
8900856	8,56	90	40	1	9	6	3	
8900857	8,57	90	40	1	9	6	3	
8900858	8,58	90	40	1	9	6	3	
8900859	8,59	90	40	1	9	6	3	
8900860	8,6	90	40	1	9	6	3	
8900861	8,61	90	40	1	9	6	3	
8900862	8,62	90	40	1	9	6	3	
8900863	8,63	90	40	1	9	6	3	
8900864	8,64	90	40	1	9	6	3	
8900865	8,65	90	40	1	9	6	3	
8900866	8,66	90	40	1	9	6	3	
8900867	8,67	90	40	1	9	6	3	
8900868	8,68	90	40	1	9	6	3	
8900869	8,69	90	40	1	9	6	3	
8900870	8,7	90	40	1	9	6	3	
8900871	8,71	90	40	1	9	6	3	
8900872	8,72	90	40	1	9	6	3	
8900873	8,73	90	40	1	9	6	3	
8900874	8,74	90	40	1	9	6	3	
8900875	8,75	90	40	1	9	6	3	
8900876	8,76	90	40	1	9	6	3	
8900877	8,77	90	40	1	9	6	3	
8900878	8,78	90	40	1	9	6	3	
8900879	8,79	90	40	1	9	6	3	
8900880	8,8	90	40	1	9	6	3	
8900881	8,81	90	40	1	9	6	3	
8900882	8,82	90	40	1	9	6	3	
8900883	8,83	90	40	1	9	6	3	
8900884	8,84	90	40	1	9	6	3	

EDP	D	L	l	l1	d	z	Type	Price
8900885	8,85	90	40	1	9	6	3	
8900886	8,86	90	40	1	9	6	3	
8900887	8,87	90	40	1	9	6	3	
8900888	8,88	90	40	1	9	6	3	
8900889	8,89	90	40	1	9	6	3	
8900890	8,9	90	40	1	9	6	3	
8900891	8,91	90	40	1	9	6	3	
8900892	8,92	90	40	1	9	6	3	
8900893	8,93	90	40	1	9	6	3	
8900894	8,94	90	40	1	9	6	3	
8900895	8,95	90	40	1	9	6	3	
8900896	8,96	90	40	1	9	6	3	
8900897	8,97	90	40	1	9	6	3	
8900898	8,98	90	40	1	9	6	3	
8900899	8,99	90	40	1	9	6	3	
8900900	9	90	40	1	9	6	3	
8900901	9,01	100	40	1	10	6	3	
8900902	9,02	100	40	1	10	6	3	
8900903	9,03	100	40	1	10	6	3	
8900904	9,04	100	40	1	10	6	3	
8900905	9,05	100	40	1	10	6	3	
8900906	9,06	100	40	1	10	6	3	
8900907	9,07	100	40	1	10	6	3	
8900908	9,08	100	40	1	10	6	3	
8900909	9,09	100	40	1	10	6	3	
8900910	9,1	100	40	1	10	6	3	
8900911	9,11	100	40	1	10	6	3	
8900912	9,12	100	40	1	10	6	3	
8900913	9,13	100	40	1	10	6	3	
8900914	9,14	100	40	1	10	6	3	
8900915	9,15	100	40	1	10	6	3	
8900916	9,16	100	40	1	10	6	3	
8900917	9,17	100	40	1	10	6	3	
8900918	9,18	100	40	1	10	6	3	
8900919	9,19	100	40	1	10	6	3	
8900920	9,2	100	40	1	10	6	3	
8900921	9,21	100	40	1	10	6	3	
8900922	9,22	100	40	1	10	6	3	
8900923	9,23	100	40	1	10	6	3	
8900924	9,24	100	40	1	10	6	3	
8900925	9,25	100	40	1	10	6	3	
8900926	9,26	100	40	1	10	6	3	
8900927	9,27	100	40	1	10	6	3	
8900928	9,28	100	40	1	10	6	3	
8900929	9,29	100	40	1	10	6	3	



- First choice in quality and performance
- Carbide straight reamer, bright finish
- From $\varnothing 0,3$ - 13,05 mm in 0,01 mm increments
- 1276 sizes

Type 1

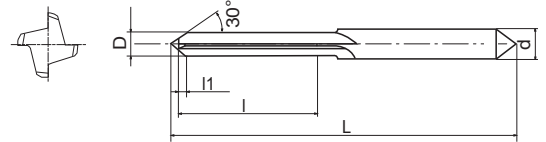

Type 2

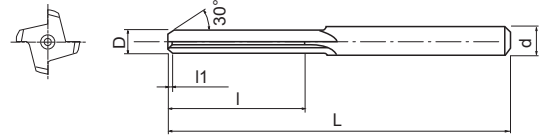

Type 3

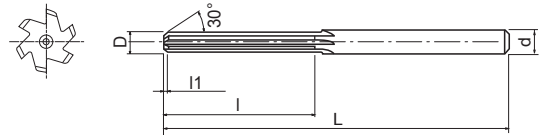

EDP	D	L	l	l1	d	z	Type	Price
8900930	9,3	100	40	1	10	6	3	
8900931	9,31	100	40	1	10	6	3	
8900932	9,32	100	40	1	10	6	3	
8900933	9,33	100	40	1	10	6	3	
8900934	9,34	100	40	1	10	6	3	
8900935	9,35	100	40	1	10	6	3	
8900936	9,36	100	40	1	10	6	3	
8900937	9,37	100	40	1	10	6	3	
8900938	9,38	100	40	1	10	6	3	
8900939	9,39	100	40	1	10	6	3	
8900940	9,4	100	40	1	10	6	3	
8900941	9,41	100	40	1	10	6	3	
8900942	9,42	100	40	1	10	6	3	
8900943	9,43	100	40	1	10	6	3	
8900944	9,44	100	40	1	10	6	3	
8900945	9,45	100	40	1	10	6	3	
8900946	9,46	100	40	1	10	6	3	
8900947	9,47	100	40	1	10	6	3	
8900948	9,48	100	40	1	10	6	3	
8900949	9,49	100	40	1	10	6	3	
8900950	9,5	100	40	1	10	6	3	
8900951	9,51	100	45	1	10	6	3	
8900952	9,52	100	45	1	10	6	3	
8900953	9,53	100	45	1	10	6	3	
8900954	9,54	100	45	1	10	6	3	
8900955	9,55	100	45	1	10	6	3	
8900956	9,56	100	45	1	10	6	3	
8900957	9,57	100	45	1	10	6	3	
8900958	9,58	100	45	1	10	6	3	
8900959	9,59	100	45	1	10	6	3	
8900960	9,6	100	45	1	10	6	3	
8900961	9,61	100	45	1	10	6	3	
8900962	9,62	100	45	1	10	6	3	
8900963	9,63	100	45	1	10	6	3	
8900964	9,64	100	45	1	10	6	3	
8900965	9,65	100	45	1	10	6	3	
8900966	9,66	100	45	1	10	6	3	
8900967	9,67	100	45	1	10	6	3	
8900968	9,68	100	45	1	10	6	3	
8900969	9,69	100	45	1	10	6	3	
8900970	9,7	100	45	1	10	6	3	
8900971	9,71	100	45	1	10	6	3	
8900972	9,72	100	45	1	10	6	3	
8900973	9,73	100	45	1	10	6	3	
8900974	9,74	100	45	1	10	6	3	

EDP	D	L	l	l1	d	z	Type	Price
8900975	9,75	100	45	1	10	6	3	
8900976	9,76	100	45	1	10	6	3	
8900977	9,77	100	45	1	10	6	3	
8900978	9,78	100	45	1	10	6	3	
8900979	9,79	100	45	1	10	6	3	
8900980	9,8	100	45	1	10	6	3	
8900981	9,81	100	45	1	10	6	3	
8900982	9,82	100	45	1	10	6	3	
8900983	9,83	100	45	1	10	6	3	
8900984	9,84	100	45	1	10	6	3	
8900985	9,85	100	45	1	10	6	3	
8900986	9,86	100	45	1	10	6	3	
8900987	9,87	100	45	1	10	6	3	
8900988	9,88	100	45	1	10	6	3	
8900989	9,89	100	45	1	10	6	3	
8900990	9,9	100	45	1	10	6	3	
8900991	9,91	100	45	1	10	6	3	
8900992	9,92	100	45	1	10	6	3	
8900993	9,93	100	45	1	10	6	3	
8900994	9,94	100	45	1	10	6	3	
8900995	9,95	100	45	1	10	6	3	
8900996	9,96	100	45	1	10	6	3	
8900997	9,97	100	45	1	10	6	3	
8900998	9,98	100	45	1	10	6	3	
8900999	9,99	100	45	1	10	6	3	
8901000	10	100	45	1	10	6	3	
8901001	10,01	100	45	1	11	6	3	
8901002	10,02	100	45	1	11	6	3	
8901003	10,03	100	45	1	11	6	3	
8901004	10,04	100	45	1	11	6	3	
8901005	10,05	100	45	1	11	6	3	
8901006	10,06	100	45	1	11	6	3	
8901007	10,07	100	45	1	11	6	3	
8901008	10,08	100	45	1	11	6	3	
8901009	10,09	100	45	1	11	6	3	
8901010	10,1	100	45	1	11	6	3	
8901011	10,11	100	45	1	11	6	3	
8901012	10,12	100	45	1	11	6	3	
8901013	10,13	100	45	1	11	6	3	
8901014	10,14	100	45	1	11	6	3	
8901015	10,15	100	45	1	11	6	3	
8901016	10,16	100	45	1	11	6	3	
8901017	10,17	100	45	1	11	6	3	
8901018	10,18	100	45	1	11	6	3	
8901019	10,19	100	45	1	11	6	3	





Type 1

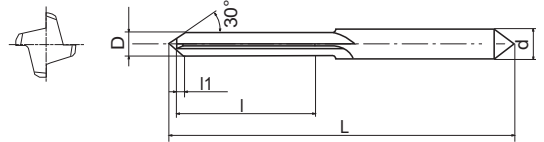

Type 2

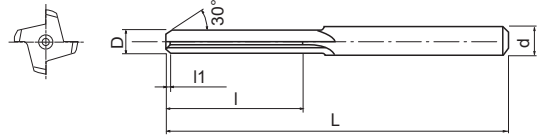

Type 3

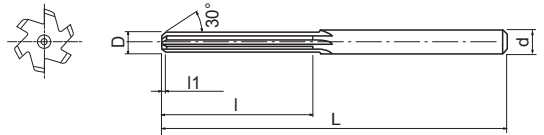

- First choice in quality and performance
- Carbide straight reamer, bright finish
- From $\varnothing 0,3$ - 13,05 mm in 0,01 mm increments
- 1276 sizes

P C: $\leq 0,2\%$	P C: $0,25-0,4\%$	P C: $\geq 0,45\%$	P SCM	K GG	N Al	N AC,ADC	H 25-35 HRC	H 35-45 HRC	H 45-52 HRC
-----------------------------	-----------------------------	------------------------------	-----------------	----------------	----------------	--------------------	-----------------------	-----------------------	-----------------------

CARBIDE	$0 \sim +0,005$	h6
----------------	-----------------	-----------

Carbide reamers

EDP	D	L	l	l1	d	z	Type	Price
8901020	10,2	100	45	1	11	6	3	
8901021	10,21	100	45	1	11	6	3	
8901022	10,22	100	45	1	11	6	3	
8901023	10,23	100	45	1	11	6	3	
8901024	10,24	100	45	1	11	6	3	
8901025	10,25	100	45	1	11	6	3	
8901026	10,26	100	45	1	11	6	3	
8901027	10,27	100	45	1	11	6	3	
8901028	10,28	100	45	1	11	6	3	
8901029	10,29	100	45	1	11	6	3	
8901030	10,3	100	45	1	11	6	3	
8901031	10,31	100	45	1	11	6	3	
8901032	10,32	100	45	1	11	6	3	
8901033	10,33	100	45	1	11	6	3	
8901034	10,34	100	45	1	11	6	3	
8901035	10,35	100	45	1	11	6	3	
8901036	10,36	100	45	1	11	6	3	
8901037	10,37	100	45	1	11	6	3	
8901038	10,38	100	45	1	11	6	3	
8901039	10,39	100	45	1	11	6	3	
8901040	10,4	100	45	1	11	6	3	
8901041	10,41	100	45	1	11	6	3	
8901042	10,42	100	45	1	11	6	3	
8901043	10,43	100	45	1	11	6	3	
8901044	10,44	100	45	1	11	6	3	
8901045	10,45	100	45	1	11	6	3	
8901046	10,46	100	45	1	11	6	3	
8901047	10,47	100	45	1	11	6	3	
8901048	10,48	100	45	1	11	6	3	
8901049	10,49	100	45	1	11	6	3	
8901050	10,5	100	45	1	11	6	3	
8901051	10,51	100	45	1	11	6	3	
8901052	10,52	100	45	1	11	6	3	
8901053	10,53	100	45	1	11	6	3	
8901054	10,54	100	45	1	11	6	3	
8901055	10,55	100	45	1	11	6	3	
8901056	10,56	100	45	1	11	6	3	
8901057	10,57	100	45	1	11	6	3	
8901058	10,58	100	45	1	11	6	3	
8901059	10,59	100	45	1	11	6	3	
8901060	10,6	100	45	1	11	6	3	
8901061	10,61	100	45	1	11	6	3	
8901062	10,62	100	45	1	11	6	3	
8901063	10,63	100	45	1	11	6	3	
8901064	10,64	100	45	1	11	6	3	

EDP	D	L	l	l1	d	z	Type	Price
8901065	10,65	100	45	1	11	6	3	
8901066	10,66	100	45	1	11	6	3	
8901067	10,67	100	45	1	11	6	3	
8901068	10,68	100	45	1	11	6	3	
8901069	10,69	100	45	1	11	6	3	
8901070	10,7	100	45	1	11	6	3	
8901071	10,71	100	45	1	11	6	3	
8901072	10,72	100	45	1	11	6	3	
8901073	10,73	100	45	1	11	6	3	
8901074	10,74	100	45	1	11	6	3	
8901075	10,75	100	45	1	11	6	3	
8901076	10,76	100	45	1	11	6	3	
8901077	10,77	100	45	1	11	6	3	
8901078	10,78	100	45	1	11	6	3	
8901079	10,79	100	45	1	11	6	3	
8901080	10,8	100	45	1	11	6	3	
8901081	10,81	100	45	1	11	6	3	
8901082	10,82	100	45	1	11	6	3	
8901083	10,83	100	45	1	11	6	3	
8901084	10,84	100	45	1	11	6	3	
8901085	10,85	100	45	1	11	6	3	
8901086	10,86	100	45	1	11	6	3	
8901087	10,87	100	45	1	11	6	3	
8901088	10,88	100	45	1	11	6	3	
8901089	10,89	100	45	1	11	6	3	
8901090	10,9	100	45	1	11	6	3	
8901091	10,91	100	45	1	11	6	3	
8901092	10,92	100	45	1	11	6	3	
8901093	10,93	100	45	1	11	6	3	
8901094	10,94	100	45	1	11	6	3	
8901095	10,95	100	45	1	11	6	3	
8901096	10,96	100	45	1	11	6	3	
8901097	10,97	100	45	1	11	6	3	
8901098	10,98	100	45	1	11	6	3	
8901099	10,99	100	45	1	11	6	3	
8901100	11	100	45	1	11	6	3	
8901101	11,01	110	45	1	12	6	3	
8901102	11,02	110	45	1	12	6	3	
8901103	11,03	110	45	1	12	6	3	
8901104	11,04	110	45	1	12	6	3	
8901105	11,05	110	45	1	12	6	3	
8901106	11,06	110	45	1	12	6	3	
8901107	11,07	110	45	1	12	6	3	
8901108	11,08	110	45	1	12	6	3	
8901109	11,09	110	45	1	12	6	3	



- First choice in quality and performance
- Carbide straight reamer, bright finish
- From Ø 0,3- 13,05 mm in 0,01 mm increments
- 1276 sizes

Type 1

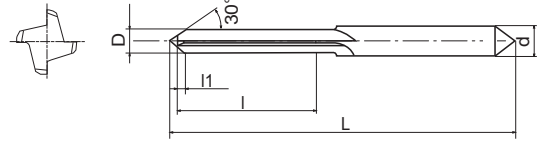

Type 2

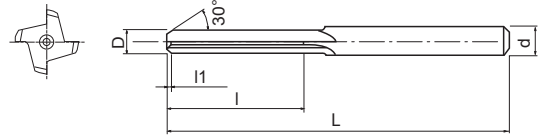

Type 3

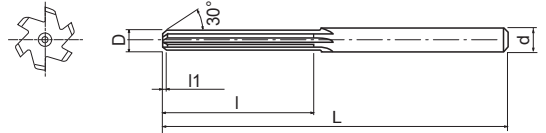

EDP	D	L	l	l1	d	z	Type	Price
8901110	11,1	110	45	1	12	6	3	
8901111	11,11	110	45	1	12	6	3	
8901112	11,12	110	45	1	12	6	3	
8901113	11,13	110	45	1	12	6	3	
8901114	11,14	110	45	1	12	6	3	
8901115	11,15	110	45	1	12	6	3	
8901116	11,16	110	45	1	12	6	3	
8901117	11,17	110	45	1	12	6	3	
8901118	11,18	110	45	1	12	6	3	
8901119	11,19	110	45	1	12	6	3	
8901120	11,2	110	45	1	12	6	3	
8901121	11,21	110	45	1	12	6	3	
8901122	11,22	110	45	1	12	6	3	
8901123	11,23	110	45	1	12	6	3	
8901124	11,24	110	45	1	12	6	3	
8901125	11,25	110	45	1	12	6	3	
8901126	11,26	110	45	1	12	6	3	
8901127	11,27	110	45	1	12	6	3	
8901128	11,28	110	45	1	12	6	3	
8901129	11,29	110	45	1	12	6	3	
8901130	11,3	110	45	1	12	6	3	
8901131	11,31	110	45	1	12	6	3	
8901132	11,32	110	45	1	12	6	3	
8901133	11,33	110	45	1	12	6	3	
8901134	11,34	110	45	1	12	6	3	
8901135	11,35	110	45	1	12	6	3	
8901136	11,36	110	45	1	12	6	3	
8901137	11,37	110	45	1	12	6	3	
8901138	11,38	110	45	1	12	6	3	
8901139	11,39	110	45	1	12	6	3	
8901140	11,4	110	45	1	12	6	3	
8901141	11,41	110	45	1	12	6	3	
8901142	11,42	110	45	1	12	6	3	
8901143	11,43	110	45	1	12	6	3	
8901144	11,44	110	45	1	12	6	3	
8901145	11,45	110	45	1	12	6	3	
8901146	11,46	110	45	1	12	6	3	
8901147	11,47	110	45	1	12	6	3	
8901148	11,48	110	45	1	12	6	3	
8901149	11,49	110	45	1	12	6	3	
8901150	11,5	110	45	1	12	6	3	
8901151	11,51	110	45	1	12	6	3	
8901152	11,52	110	45	1	12	6	3	
8901153	11,53	110	45	1	12	6	3	
8901154	11,54	110	45	1	12	6	3	

EDP	D	L	l	l1	d	z	Type	Price
8901155	11,55	110	45	1	12	6	3	
8901156	11,56	110	45	1	12	6	3	
8901157	11,57	110	45	1	12	6	3	
8901158	11,58	110	45	1	12	6	3	
8901159	11,59	110	45	1	12	6	3	
8901160	11,6	110	45	1	12	6	3	
8901161	11,61	110	45	1	12	6	3	
8901162	11,62	110	45	1	12	6	3	
8901163	11,63	110	45	1	12	6	3	
8901164	11,64	110	45	1	12	6	3	
8901165	11,65	110	45	1	12	6	3	
8901166	11,66	110	45	1	12	6	3	
8901167	11,67	110	45	1	12	6	3	
8901168	11,68	110	45	1	12	6	3	
8901169	11,69	110	45	1	12	6	3	
8901170	11,7	110	45	1	12	6	3	
8901171	11,71	110	45	1	12	6	3	
8901172	11,72	110	45	1	12	6	3	
8901173	11,73	110	45	1	12	6	3	
8901174	11,74	110	45	1	12	6	3	
8901175	11,75	110	45	1	12	6	3	
8901176	11,76	110	45	1	12	6	3	
8901177	11,77	110	45	1	12	6	3	
8901178	11,78	110	45	1	12	6	3	
8901179	11,79	110	45	1	12	6	3	
8901180	11,8	110	45	1	12	6	3	
8901181	11,81	110	50	1	12	6	3	
8901182	11,82	110	50	1	12	6	3	
8901183	11,83	110	50	1	12	6	3	
8901184	11,84	110	50	1	12	6	3	
8901185	11,85	110	50	1	12	6	3	
8901186	11,86	110	50	1	12	6	3	
8901187	11,87	110	50	1	12	6	3	
8901188	11,88	110	50	1	12	6	3	
8901189	11,89	110	50	1	12	6	3	
8901190	11,9	110	50	1	12	6	3	
8901191	11,91	110	50	1	12	6	3	
8901192	11,92	110	50	1	12	6	3	
8901193	11,93	110	50	1	12	6	3	
8901194	11,94	110	50	1	12	6	3	
8901195	11,95	110	50	1	12	6	3	
8901196	11,96	110	50	1	12	6	3	
8901197	11,97	110	50	1	12	6	3	
8901198	11,98	110	50	1	12	6	3	
8901199	11,99	110	50	1	12	6	3	





Type 1

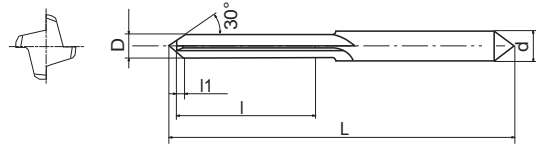

Type 2

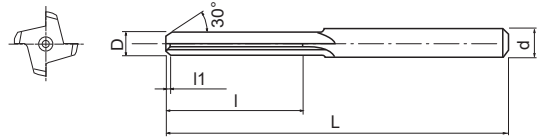

Type 3

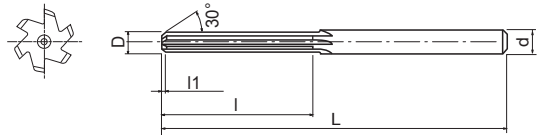

- First choice in quality and performance
- Carbide straight reamer, bright finish
- From Ø 0,3- 13,05 mm in 0,01 mm increments
- 1276 sizes

P C: ≤0,2%	P C: 0,25-0,4%	P C: ≥0,45%	P SCM	K GG	N Al	N AC,ADC	H 25-35 HRC	H 35-45 HRC	H 45-52 HRC
----------------------	--------------------------	-----------------------	-----------------	----------------	----------------	--------------------	-----------------------	-----------------------	-----------------------

CARBIDE	0~+0.005	h6
----------------	----------	-----------

Carbide reamers

EDP	D	L	l	l1	d	z	Type	Price
8901200	12	110	50	1	12	6	3	
8901201	12,01	110	50	1	13	6	3	
8901202	12,02	110	50	1	13	6	3	
8901203	12,03	110	50	1	13	6	3	
8901204	12,04	110	50	1	13	6	3	
8901205	12,05	110	50	1	13	6	3	
8901206	12,06	110	50	1	13	6	3	
8901207	12,07	110	50	1	13	6	3	
8901208	12,08	110	50	1	13	6	3	
8901209	12,09	110	50	1	13	6	3	
8901210	12,1	110	50	1	13	6	3	
8901211	12,11	110	50	1	13	6	3	
8901212	12,12	110	50	1	13	6	3	
8901213	12,13	110	50	1	13	6	3	
8901214	12,14	110	50	1	13	6	3	
8901215	12,15	110	50	1	13	6	3	
8901216	12,16	110	50	1	13	6	3	
8901217	12,17	110	50	1	13	6	3	
8901218	12,18	110	50	1	13	6	3	
8901219	12,19	110	50	1	13	6	3	
8901220	12,2	110	50	1	13	6	3	
8901221	12,21	110	50	1	13	6	3	
8901222	12,22	110	50	1	13	6	3	
8901223	12,23	110	50	1	13	6	3	
8901224	12,24	110	50	1	13	6	3	
8901225	12,25	110	50	1	13	6	3	
8901226	12,26	110	50	1	13	6	3	
8901227	12,27	110	50	1	13	6	3	
8901228	12,28	110	50	1	13	6	3	
8901229	12,29	110	50	1	13	6	3	
8901230	12,3	110	50	1	13	6	3	
8901231	12,31	110	50	1	13	6	3	
8901232	12,32	110	50	1	13	6	3	
8901233	12,33	110	50	1	13	6	3	
8901234	12,34	110	50	1	13	6	3	
8901235	12,35	110	50	1	13	6	3	
8901236	12,36	110	50	1	13	6	3	
8901237	12,37	110	50	1	13	6	3	
8901238	12,38	110	50	1	13	6	3	
8901239	12,39	110	50	1	13	6	3	
8901240	12,4	110	50	1	13	6	3	
8901241	12,41	110	50	1	13	6	3	
8901242	12,42	110	50	1	13	6	3	
8901243	12,43	110	50	1	13	6	3	
8901244	12,44	110	50	1	13	6	3	

EDP	D	L	l	l1	d	z	Type	Price
8901245	12,45	110	50	1	13	6	3	
8901246	12,46	110	50	1	13	6	3	
8901247	12,47	110	50	1	13	6	3	
8901248	12,48	110	50	1	13	6	3	
8901249	12,49	110	50	1	13	6	3	
8901250	12,5	110	50	1	13	6	3	
8901251	12,51	110	50	1	13	6	3	
8901252	12,52	110	50	1	13	6	3	
8901253	12,53	110	50	1	13	6	3	
8901254	12,54	110	50	1	13	6	3	
8901255	12,55	110	50	1	13	6	3	
8901256	12,56	110	50	1	13	6	3	
8901257	12,57	110	50	1	13	6	3	
8901258	12,58	110	50	1	13	6	3	
8901259	12,59	110	50	1	13	6	3	
8901260	12,6	110	50	1	13	6	3	
8901261	12,61	110	50	1	13	6	3	
8901262	12,62	110	50	1	13	6	3	
8901263	12,63	110	50	1	13	6	3	
8901264	12,64	110	50	1	13	6	3	
8901265	12,65	110	50	1	13	6	3	
8901266	12,66	110	50	1	13	6	3	
8901267	12,67	110	50	1	13	6	3	
8901268	12,68	110	50	1	13	6	3	
8901269	12,69	110	50	1	13	6	3	
8901270	12,7	110	50	1	13	6	3	
8901271	12,71	110	50	1	13	6	3	
8901272	12,72	110	50	1	13	6	3	
8901273	12,73	110	50	1	13	6	3	
8901274	12,74	110	50	1	13	6	3	
8901275	12,75	110	50	1	13	6	3	
8901276	12,76	110	50	1	13	6	3	
8901277	12,77	110	50	1	13	6	3	
8901278	12,78	110	50	1	13	6	3	
8901279	12,79	110	50	1	13	6	3	
8901280	12,8	110	50	1	13	6	3	
8901281	12,81	110	50	1	13	6	3	
8901282	12,82	110	50	1	13	6	3	
8901283	12,83	110	50	1	13	6	3	
8901284	12,84	110	50	1	13	6	3	
8901285	12,85	110	50	1	13	6	3	
8901286	12,86	110	50	1	13	6	3	
8901287	12,87	110	50	1	13	6	3	
8901288	12,88	110	50	1	13	6	3	
8901289	12,89	110	50	1	13	6	3	

CRM

Carbide reamers

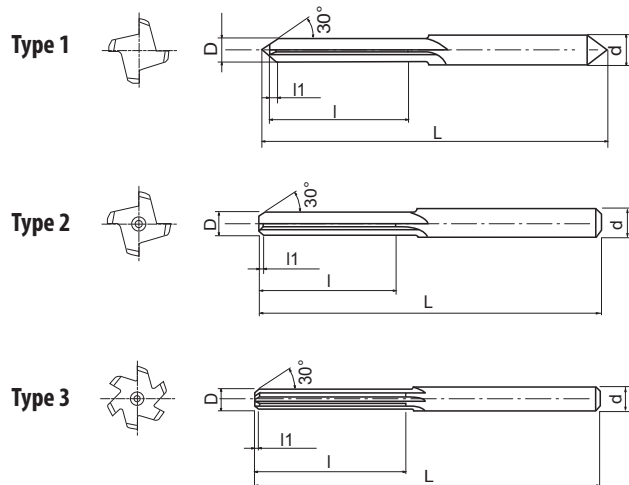

- First choice in quality and performance
- Carbide straight reamer, bright finish
- From Ø 0,3- 13,05 mm in 0,01 mm increments
- 1276 sizes

Material and hardness options:

- P** C: ≤0,2%
- P** C: 0,25-0,4%
- P** C: ≥0,45%
- P** SCM
- K** GG
- N** AI
- N** AC,ADC
- H** 25-35 HRC
- H** 35-45 HRC
- H** 45-52 HRC

Properties:

- CARBIDE**
- $0_{-0,005}$
- h6**

EDP	D	L	l	l1	d	z	Type	Price
8901290	12,9	110	50	1	13	6	3	
8901291	12,91	110	50	1	13	6	3	
8901292	12,92	110	50	1	13	6	3	
8901293	12,93	110	50	1	13	6	3	
8901294	12,94	110	50	1	13	6	3	
8901295	12,95	110	50	1	13	6	3	
8901296	12,96	110	50	1	13	6	3	
8901297	12,97	110	50	1	13	6	3	
8901298	12,98	110	50	1	13	6	3	
8901299	12,99	110	50	1	13	6	3	
8901300	13	110	50	1	13	6	3	
8901301	13,01	110	50	1	14	6	3	
8901302	13,02	110	50	1	14	6	3	
8901303	13,03	110	50	1	14	6	3	
8901304	13,04	110	50	1	14	6	3	
8901305	13,05	110	50	1	14	6	3	

EDP	D	L	l	l1	d	z	Type	Price

Carbide reamers





shaping your dreams

OSG EUROPE LOGISTICS

Avenue Lavoisier 1
B-1300 Z.I. Wavre - Nord - Belgium
Tel: +32 10 23 05 07
Fax: +32 10 23 05 51
info@osgeurope.com

OSG BELUX

Avenue Lavoisier 1
B-1300 Z.I. Wavre - Nord - Belgium
Tel: +32 10 23 05 11
Fax: +32 10 23 05 31
info@osg-belgium.com

OSG FRANCE

Parc Icade, Paris Nord 2
Immeuble "Le Rimbaud"
22 Avenue des Nations
CS66191 - 93420 Villepinte - France
Tel: +33 1 49 90 10 10
Fax: +33 1 49 90 10 15
sales@osg-france.com

OSG NETHERLANDS

Bedrijfsweg 5 - 3481 MG Harmelen
Tel: +31 348 44 2764
Fax: +31 348 44 2144
info@osg-nl.com

OSG UK

Shelton house, 5 Bentalls
Pipps Hill Ind Est, Basildon Essex SS14 3BY
Tel: +44 845 305 1066
Fax: +44 845 305 1067
sales@osg-uk.com

SLOVAKIA

Branch office of OSG Europe Logistics s.a.
Tel (SK) +421 2 4329 1295
Tel (BE) +32 10 23 05 07
Fax (BE) +32 10 23 05 51
sales-osgsvk@osgeurope.com

OSG POLAND Sp. z.o.o.

Spółdzielcza 57
05-07 Halinów - Poland
Tel: +22 760 82 71
Fax: +22 760 82 71
osg@osg-poland.com

OSG GERMANY

Karl-Ehmann-Str. 25
D - 73037 Göppingen - Germany
Tel: +49 7161 6064 - 0
Fax: +49 7161 6064 - 444
info@osg-germany.de

OSG SCANDINAVIA

(For Scandinavian countries)
Langebjergvaenget 16
4000 Roskilde - Denmark
Tel: +45 46 75 65 55
Fax: +45 46 75 67 00
osg@osg-scandinavia.com

SWEDEN

Branch office of OSG SCANDINAVIA
Abrahams Gränd 8
295 35 Bromölla - Sweden
Tel: +46 40 41 22 55
Fax: +46 40 41 32 55
osg@osg-scandinavia.com

OSG IBERICA

Bekolarra 4
E - 01010 Vitoria-Gasteiz - Spain
Tel: +34 945 242 400
Fax: +34 945 228 883
osg.iberica@osg-ib.com

RUSSIA

Butlerova street, 17B, office 5069
117342 Moscow - Russia
Tel: +7 (495) 150 41 54
info@osg-russia.com

OSG TURKEY

Rami Kişla Cad.No:56 Eyüp
Istanbul 34056 - Turkey
Tel:+90 212 565 24 00
Fax: +90 212 565 44 00
info@osg-turkey.com

ROMSAN INTERNATIONAL CO. SRL

Reprezentant Exclusiv OSG
23-25, Nerva Traian Street
031044 Bucuresti - România
Tel: +40 021 322 07 47
Fax: +40 021 321 56 00
romsan.int@romsan.ro

AUSTRIA

Branch office of OSG GERMANY
Messestraße 11
A-6850 Dornbirn
Tel: +49 7161 6064-0
Fax: +49 7161 6064-444
info@osg-germany.de

OSG ITALIA

Via Cirenaiça n. 52 int. 61/63
I - 10142 Torino - Italy
Tel: +39 0117705211
Fax: +39 0117071402
info@osg-italia.it

WEXO PRÄZISIONSWERKZEUGE GmbH

Siemensstraße 13
D-61352 Bad Homburg
Tel: (06172) 10 62 06
Fax: (06172) 10 62 13
verkauf@wexo.com

OSG EUROPE LOGISTICS S.A.

11/2017 - All rights reserved. © OSG Europe 2017.

The contents of this catalogue are provided to you for viewing only. They are not intended for reproduction either in part or in whole in this or other medium. They cannot be copied, used to create derivation work or used for any reason, by means without the express, written permission of the copyright owner. If prices are stated, they are netto unit-prices and any eventual tax(es) have to be added. The company is not responsible for any printing error in technical, price and/or any other data.

Tool specifications subject to change without notice.

www.osgeurope.com